



INVOTEC®

ENT and Plastic Surgery



TERMS AND CONDITIONS

PLACING YOUR ORDER

For your convenience, orders may be placed via email, fax, or phone. We will ship ground unless otherwise specified.

Email: orders@invotec.net

Fax: (904) 886-9517

Phone: (800) 998-8580

PAYMENT TERMS

Our payment terms are net thirty (30) days. F.O.B. Jacksonville, FL unless otherwise specified.

ACCEPTANCE

All orders are subject to approval and acceptance from Invotec International, Inc. which reserves the right to alter or suspend credit, cancel unfilled orders or refuse shipment when credit conditions warrant such action.

PRODUCT SPECIFICATIONS AND AVAILABILITY

Invotec reserves the right to discontinue merchandise, make design improvements, change specifications, prices, terms or conditions of sale at any time without notice or obligation.

PACKAGING AND SHIPMENTS

- A. Processing of all orders begins immediately.
- B. All items shall be packaged and shipped in accordance with Invotec's best judgment. Special packaging or shipping instructions must be noted on the original order and acknowledged by Invotec.
- C. Shipment is F.O.B. Jacksonville, FL.
- D. Shipment dates are based on Invotec's best estimates. Invotec will exercise its best efforts to ship on schedule, but shall not be liable for damage or loss because of any delay in delivery.
- E. Invotec reserves the right to fill any order by complete or partial shipments unless otherwise agreed.
- F. Invotec's responsibility for loss or damage to goods ends upon delivery of those goods to the transporting company. If Invotec paid for shipping, we will assist you in any reasonable manner in filing claims for damaged or lost merchandise.
- G. Invotec shall not be liable for any failure or delay in delivery caused in whole or in part by any governmental act or regulation, civil commotion, delay of carriers, destruction of plants, fire, inability to obtain materials or shipping space, lockouts, strikes, wars, or any other cause beyond our control.

COMPLAINT HANDLING

If you encounter a problem or complaint, please do the following: 1) obtain all relevant facts, including the name of user, address, phone number, merchandise number, lot/serial number, date of occurrence and description of circumstances or nature of problem; and 2) report information immediately to Invotec's Customer Service Department at the number listed above. Every effort will be made to address and resolve problems in a manner consistent with our goal of providing quality merchandise and services.

RETURNED GOODS POLICY

No merchandise may be returned without the prior authorization of Invotec. All returns must be accompanied by a Returned Goods Authorization (RGA) number. This number can be obtained by calling our Customer Service Department. To request an RGA number, please have the following information when calling Customer Service: 1) original invoice number or purchase order number, 2) sales order number, 3) catalog number, 4) quantity, 5) lot number, 6) and reason for return. Please display the RGA number prominently on the box and include it on all paperwork. All authorized returns must be sent freight prepaid.

- A. All returned merchandise must be in its original package. Any merchandise returned that is obsolete, beyond its expiration date, defaced, altered, damaged or has come in contact with body tissue or fluids will not be eligible for return or credit. Sterile merchandise must be returned in full-box quantities with the outer seals intact.
- B. Merchandise returned in unopened, unused, undamaged condition within 60 days of the date of purchase will be credited at the customer's purchase price.
- C. Merchandise returned unused after 60 days and before 180 days from date of purchase will be credited at actual purchase prices less 25% restocking fees.
- D. Merchandise returned after 180 days from date of purchase is not eligible for return or credit.
- E. Altered or custom made items are not eligible for return or credit.
- F. If you are enrolled in the New Product Evaluation Guarantee Program and have a return, Invotec will refund you the purchase price for product purchased on an initial evaluation order subject to the conditions outlined in your warranty.
- G. Merchandise returned without prior authorization or not in accordance with the terms and conditions outlined above will be returned to the customer at the customer's expense.

RETURN OF MERCHANDISE FOR REPAIR

To arrange for the return of merchandise for repair, call Customer Service at (800) 998-8580 to obtain a Returned Goods Authorization (RGA) number and to schedule the repair. Please have the original invoice number or purchase order number available to assist in verifying warranty information.

A purchase order number is required to process all repairs. After obtaining a RGA number, Customer Service will inform you of the repair charge that will be billed to your purchase order.

The RGA number should be prominently displayed on the box and should be included on all paperwork enclosed with the merchandise requiring repair. Merchandise returned for repair should be safely packaged in protective wrapping. Customer must include with the returned merchandise the 1) purchase order number, 2) correct shipping and billing address, and 3) Repair Order Form or customer statement of problem/reason for repair.

ALL REPAIRS SHOULD BE SHIPPED FREIGHT PREPAID TO:

Invotec International, Inc.
6833 Phillips Industrial Blvd.
Jacksonville, FL 32256
ATTN: RGA # _____

IMPORTANT

Due to the potential threat to health, all instruments and devices returned for repair must have been decontaminated and/or sterilized. Any product received in an unsanitary condition will be deemed un-repairable and discarded unless Invotec is able to sterilize or decontaminate the product. An additional service fee of \$250.00 will be applied to the cost of the repair of any product requiring sterilization or decontamination by Invotec.

LOANER POLICY FOR REPAIRS

Loaners for merchandise that is being repaired under warranty are provided at no charge and must be returned to Invotec within ten (10) days after customer's receipt of repaired merchandise. If the loaner is not returned within the allotted timeframe, Invotec reserves the right to charge a daily rental fee. Rental fees will continue to be charged until the loaner is returned to Invotec.

Customer shall be responsible for any damage to loaner equipment while in customer's possession or during shipping back to Invotec. Customer is responsible for all shipping charges associated with the loaner's return.

REPAIR WARRANTIES

All repairs are warranted to be free from defects in material and workmanship for ninety (90) days after the date of shipment.

CHANGES TO TERMS

Invotec retains the right to change any of these terms or conditions without notice.

WARRANTY

Invotec International, Inc. warrants that the merchandise is free from defects in material and workmanship. Invotec will replace or provide a refund for any merchandise found to be defective so long as the merchandise is returned according to the Returned Goods Policy. Invotec shall not be liable for any consequential loss, damage or expense directly or indirectly arising from the use or misuse of, or inability to use, this merchandise. THE FOREGOING WARRANTY IS IN LIEU OF AND EXCLUDES ALL OTHER WARRANTIES, EXPRESSED OR IMPLIED, HOWEVER ARISING, INCLUDING MERCHANTABILITY, FITNESS FOR A PARTICULAR PURPOSE, AGAINST INFRINGEMENT OR OTHERWISE. Invotec neither assumes nor authorizes any person to assume for it, any other additional liability or responsibility with respect to this merchandise.

Care and Handling of Surgical Instruments

The methods discussed have been validated for cleaning and sterilizing medical devices distributed by Invotec International and other fine surgical instrument suppliers. They have been developed using standard equipment and practices common to most health care facilities. Manual cleaning methods, steam and ETO sterilization were used as much as possible.

The Sterilization Guidelines presented are based on type of product, placed into specific categories.

Category	Type of Product
Instruments with rough surfaces	Applicators, burs, rasps, brushes, curettes
Instruments with sliding hinges	Adenotomes, forceps, punches, rongeur
Instruments with screw pivot hinges	Scissors, specula, retractors, calipers
Instruments whose surfaces that can be marred, scored, or scratched.	Mallet heads, cutting blocks, Instruments made of or having Delrin® (Dupont™) surfaces, specula, mixing bowls.
Instruments with lumens and channels	Suction tips, cannulas, needles.

Recommended Cleaning Supplies:

- Enzyme solution (i.e. Klenszyme®), detergent (Manu-Klenz®) lukewarm water, soft bristle brush, and a clean soft towel.
- Detergents: Proteolytic enzymatic detergents with a pH range between 6.0 and 8.0 should be used. These detergents have nonionic surfactants. Detergents should be used in a concentration level recommended by the manufacturer. NOTE: Undiluted detergents and those with pH's greater than 8.0 can strip the coloration from metal instruments.
- Ultrasonic Cleaners designed for fine cleaning of medical devices.

Cleaning Procedure:

1. Soak for a minimum of two (2) minutes in enzyme solution
2. Rinse thoroughly under lukewarm water
3. Manually clean with a soft bristle brush while immersed in a detergent solution, paying close attention to crevices and hard-to-clean areas.
 - a. If using a power washer, close adherence to washer manufacturers' procedures should be followed.
4. Rinse thoroughly under lukewarm water
5. Dry with a clean soft cloth
6. Visibly examine for damage, rust deposits, and cleanliness.

Sterilization Recommendations

Device Type	Prevacuum Wrapped	Prevacuum Unwrapped	Gravity Unwrapped	Gravity wrapped	EO	Chemical Disinfectant	Chemical Sterilant	Peracetic Acid	Gas Plasma
Rough Surfaces	YES	YES	YES	YES	YES	YES	YES	YES	YES
Sliding Hinges	YES	YES	YES	YES	YES	YES	YES	YES	YES
Lever Hinges	YES	YES	YES	YES	YES	YES	YES	YES	YES
Screw Pivot	YES	YES	YES	YES	YES	YES	YES	YES	YES
Lumens	YES	YES	YES	YES	YES	YES	YES	NO	YES
Sterilization Trays	YES	YES	YES	YES	YES	YES	YES	NO	NO
Steam Sterilizable Endoscopes	YES	YES	YES	YES	YES	YES	YES	YES	YES

A “**NO**” indicates Invotec International does not have the data to support the recommendation of the specific method of sterilization for a given category.

Cycle Parameters

Prevacuum Cycle (wrapped and unwrapped): Three (3) preconditioning pulses with a minimum exposure time of 4 minutes at 270 °F (132 °C).

Gravity Cycle (wrapped): 270 °F (132 °C) with a minimum exposure time of 15 minutes.

Gravity Cycle (Unwrapped): 270 °F (132 °C) with a minimum exposure time of 10 minutes.

Ethylene Oxide Cycle

Sterilant	Temperature	Humidity	Preconditioning	Concentration	Exposure
100% EO	131 °F (55 °C)	65-75%	1 hour	725 mg/l	120-360 minutes
Aerate a minimum of 12 hours at 131 °F (55 °C)					

Liquid Chemical Cycle

Concentration of Glutaraldehyde	Temperature	Exposure for Disinfection	Exposure for Sterilization
2.4%	77 °F (25 °C)	45 minutes	10 hours

- **Implants** are sold as one-time use items and not intended for re-sterilization.
- Most reusable instruments are sold nonsterile. These devices should be placed into suitable packaging for the sterilization process (i.e., central supply wrap (CSR), autoclave bags, paper/Tyvek® pouches, dedicated sterilization trays and sterilized prior to use. **All instruments should be examined and cleaned prior to sterilization.**

INVOTEC®

ACCESSORIES

RHINOLOGY AND COSMETIC SURGERY	Swiss Therapy™ Cold Therapy	1
	Scar Sheeting	2
	Skin Markers	3
	Micro Electro Dissection Needle	3
	Chin Implants	4
	Malar Implants	5
	Implantable Silicone Blocks	5
	Nasal Dorsal Implants	6-7
	Silicone Sheeting, Tubing and Blocks	8
	Septal Buttons	8
	Internal Nasal Splints	9-10
	External Nasal Splints	11
	Dressing and Packing	12-13
	Gelatin Packing	14
	Hyaluronic Acid Gel Packing	15
	Silicone Epistaxis Balloon	16
	Rhinology Knives and Blades	17
DISPOSABLE SUCTIONS	Rhinologic and Otologic	21-22
OTOLOGY	Dressing and Packing	25
	Burs	26
	Myringotomy Knives & ENT Blades	27-29
	Phenol Applicator	30
	Myringotomy Kits & Specula	31
	Ventilation Tubes	32-34
	Otovent® Middle Ear Auto Inflation	35
OSSICULAR PROTHESIS	Incus	39-40
	Incus-Stapes	41
	Partial	42-43
	Total	44-45
	Canal Wall	45
	Caps and Shoes	47
	Stapes	48-49
	Bucket Handles	50
	Nitinol Stapes	51
	Instrumentation	52
	Trials	53
	Accessories	54
LARYNGEAL	Endoscope Covers	57
	Tracheal T-tubes	58
	Disposable Adenoid Currettes	59
	Surface Electrodes	60
SPECIALTY PRODUCTS	Lighting Systems	63-66
	Ophthalmic Sponge Packing	67
	Anti-fog	68
	Head Support	68
	Cotton Tipped Applicators	68
	Sterilization Trays	69

RHINOLOGY INSTRUMENTS

Telescopes	73-74
Forceps	75-83
Antrum Punches, Back Biters and Kerrisons	84-89
Nasal Scissors	90-94
Knives and Blades	95
Osteotomes, Chisels and Saws	96-99
Elevators and Probes	100-101
Septum Instruments	102-103
Curettes	104-105
Speculas	106-108
Retractors, hooks	109-112
Rasps	113-115
Sinus Suction Tips	116-117
Mallets	118
Needle Holders, Wire Twisters	119-122
Tissue Thumb Forceps	123
Miscellaneous Nasal and Sinus	124-126
Measuring Instruments	127

PARANASAL, SKULL BASE, PITUITARY INSTRUMENTS

Retractors	131
Forceps	132-133

OTOLOGY INSTRUMENTS

TUNING FORKS	Tuning Forks	137
EXTERNAL EAR CANAL INSTRUMENTS	Ear Speculum	138-139
	Ear Curettes	140
	Loops & Hooks	141-143
	Probes	143
	Tympanum Perforators	144-145
	Ear Catheters	146
	Air Bags	147
	Powder Blower	147
MIDDLE EAR INSTRUMENTS	Instrument Set	148
	Suctions	149-150
	Elevators	151-152
	Snares	153
	Rongeurs	154
	Ear Forceps	155-160
	Ear Scissors	161
	Malleus Forceps	162

Needles/Picks	163
Hooks	164-165
Tympanoplasty Knives	166-169
Micro Elevators	170-171
Stapes Curettes	172
Footplate Drill	173
Mobilizers	174
Measuring & Cutting	175

LARYNGEAL INSTRUMENTS

MICRO LARYNGOSCOPY	Operating Laryngoscopes	179-180
	Scissors and Forceps	181-187
	Micro Knives and Elevators	188-189
	Suctions	190-191
	Injection Needles	192
LASER MICRO SURGERY	Suctions and Protectors	193-194
BRONCHO-ESOPHAGOSCOPY	Forceps	195-198
	Suctions	199
	Accessories	200

ORO-NASOPHARYNGEAL INSTRUMENTS

Adenotomes	203
Adenoid Curettes	204-206
Laryngeal Mirrors	207-208
Mouth Gags - Tongue Depressors	209-215
Retractors	216-218
Tongue Spatulas	219-221
Nasopharynx Forceps	222-225
Tonsil Artery Forceps	226-227
Tonsil Seizing Forceps	228-229
Tonsil Knives	230-231
Tonsil Screws	232
Tonsil Dissectors	233-234
Tonsil Scissors	235-236
Tonsil Snares	237-239
Tonsiltome	240
Tonsillectomy Instruments	241-242
Tonsil Needles	243
Tonsil Suctions	244-245
Tonsil Accessories	246

RHINOLOGY & COSMETIC SURGERY

R&CS ACC

DIS

OTO ACC

OSS

LAR ACC

SPE ACC

RHI INS

PSB

OTO INS

LAR INS

ORG/NAS INS

Invotec's Swiss Therapy® Masks and Sheeting are synthesized from a patented Hydrogel material. It is used as a lightweight and flexible cold compress during and after cosmetic procedures of the face.

- Moist, but not wet
- Lightweight & comfortable
- Gently pliable & conforming
- Non-adherent
- Highly patient compliant
- Convenient, easy to use
- Soothing to skin
- Sterile

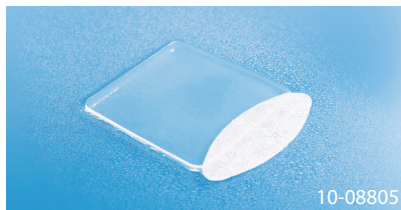
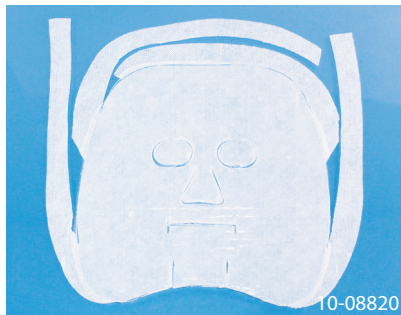

SWISS THERAPY® EYE AND FULL FACE MASKS

An easy to use, post-operative cold compress for a variety of plastic surgery or cosmetic procedures involving the facial area. While comforting to the patient, it reduces post-operative swelling, redness and discomfort, decreases healing time, and enables the patient to return to normal activities more quickly, increasing the patient's satisfaction.

Superior Post-Operative Compress with Swiss Therapy

- Conforms better to the contours of the face
- Does not leak
- Does not put pressure on or stick to the skin
- Provides superior post-operative wound monitoring, while absorbing and providing pain relief

Number	Description		Qty/Box
10-08803	Swiss Therapy® eye mask	Sterile	3
10-08813	Swiss Therapy® eye mask	Reinforced Sterile	3
10-08820	Swiss Therapy® Full face mask	Sterile	2

LASER & IPL SKIN THERAPY THROUGH SWISS THERAPY® SHEET

Provides cooling local anesthetic and pain relieving effects during and after Laser and IPL and before or after injectable therapies. The immediate application of Swiss Therapy® provides a soothing, refreshing, and relaxing feeling. Further, Swiss Therapy® reduces the risk of hematoma formation and is beneficial in restoring strength and mobility more quickly so that patients can heal faster and feel better sooner.

Injection Therapy with Swiss Therapy

Your injectable therapy patient's aesthetic procedure experience can be optimized via the cooling comfort provided, before and after injection.

- Soothe the skin, reduce redness
- Minimize skin irritation
- Relieve burning sensations
- Control adverse effects commonly associated with Botox® and other injectable therapies

Laser Therapy with Swiss Therapy

Swiss Therapy® hydrogel sheeting is a convenient and non-aggressive strategy for cooling and protecting the epidermis during and after laser and IPL procedures.

- Virtually no prism effect when performing procedures through Swiss Therapy® sheeting
- Prevents the escape of tissue splatter and smoke plumes, while maximizing patient comfort

Number	Description		Qty/Box
10-08805	Swiss Therapy® Sheet, 10 cm x 10 cm x 3.5 mm	Sterile	5
10-08806	Swiss Therapy® Sheet, 7 cm x 12 cm x 3.5 mm	Sterile	5
10-08807	Swiss Therapy® Sheet, 5 cm x 9 cm x 3.3 mm	Sterile	5

Swiss Therapy® Pad Indications

- Can be used in with all laser systems (Q-switched, pulsed), and arc lamps in the therapeutic wavelength range of 500-1100nm without affecting transmission of the laser energy. Swiss Therapy should not be used with wavelengths less than 500nm or more than 1100nm or in laser therapies using lasers with integrated, liquid coolant based cooling systems.
- Non-ablative dermo-cosmetic medical laser products only.

SILICONE SCAR SHEETS

Transparent, soft, elastic and self-adhesive sheet dressing. Effective in preventing the formation of new scars and reducing the appearance of existing scars. It is easily applied to all areas of skin including exposed or hard-to-treat areas like the face, ears, arms, hands and joints.

- Crystal clear 100% medical grade silicone gel sheeting
- Provides elastic protection to the skin for optimal scar healing
- Durable, comfortable and re-usable
- Various in shapes, sizes and backing colors
- No irritation, no maceration
- Latex free
- Trimmable
- Durable and reusable



12-75453



12-12080

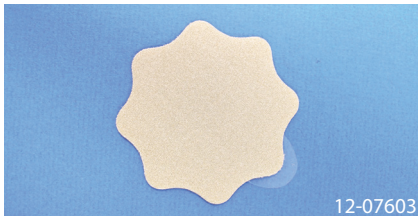

12-07603

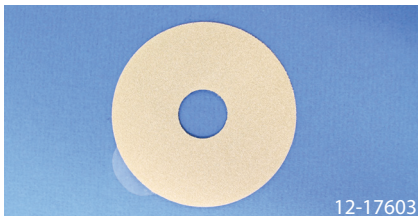

12-17603

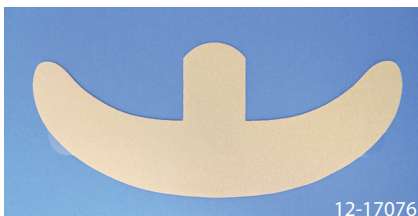

12-17076

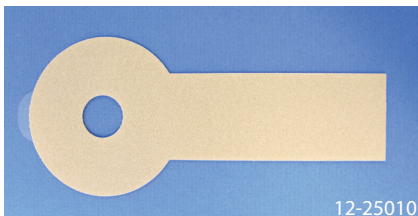

12-25010

Number	Description		Size	Gel Thickness	Qty/Box
12-75453	Sheet Dressing		75 mm x 45 mm	0.5 mm	10
12-12080	Sheet Dressing		120 mm x 80 mm	0.5 mm	10
12-07603	Nipple Cover	fabric backing	76 mm	0.3 mm	10
12-17603	Areola	fabric backing	76 mm	0.3 mm	10
12-17076	Mastopexy	fabric backing	170 mm x 76 mm	0.3 mm	10
12-25010	Anchor	fabric backing	250 mm x 100 mm	0.3 mm	10

INK SKIN MARKER

The first prep resistant ink skin marker to virtually eliminate the need for remarking of the patient even after prepping with common alcohol-based antiseptics such as ChloroPrep® or Duraprep™. Successful in millions of clinical trials, the XL features patent-pending ink that remains visible after prepping patients.

- Visible up to 10 times longer than traditional ink skin markers
- Ultra Fine Tip
- Sterile
- Includes ruler



Number	Description	Qty/Box
1448XLSR	XL Prep Resistant Ink	100

ELECTROCAUTERY DISSECTION MICRO-NEEDLE

- Blepharoplasty
- Incising Temporalis Fascia
- Otoplasty
- Bicornal flap
- Cleft lip revision
- Rhinoplasty
- Tungsten tip



Number	Description	Qty/Box
29-10000	55 mm long, exposed 3mm tip, straight blue insulated	1

MEDICAL GRADE SILICONE SHEETING

Number	I.D. x O.D.	Qty/box
STERILE		
20-10680	55 mm x 75 mm x 1.0 mm (2.2 x 3.0 x .040")	5 pair
20-10680S	55 mm x 75mm x 1.0 mm (2.2 x 3.0 x .040")	10
20-10681	55mm x 75mm x 0.25mm (2.2 x 3.0 x .010")	10
20-10682	55 mm x 75 mm x 0.5 mm (2.2 x 3.0 x .020")	5 pair
20-10682S	55 mm x 75 mm x 0.5 mm (2.2 x 3.0 x .020")	10
20-10685	38 mm x 51 mm x .13 mm (1.5 x 2.0 x .005")	10
20-10685B	38 mm x 51 mm x .13 mm (1.5 x 2.0 x .005")	10
20-10686	55 mm x 75 mm x 1.5 mm (2.2 x 3.0 x .060")	5 pair
20-10686S	55 mm x 75 mm x 1.5 mm (2.2 x 3.0 x .060")	10
NON-STERILE		
20-20680	11 cm x 15 cm x 1.0 mm (4.5 x 6.0 x .040")	10
20-20682	11 cm x 15 cm x 0.5 mm (4.5 x 6.0 x .020")	10
20-20685	11 cm x 15 cm x .13 mm (4.5 x 6.0 x .005")	10
20-20686	11 cm x 15 cm x 1.5 mm (4.5 x 6.0 x .060")	10
20-30002	30 cm x 30 cm x .06 mm (12 x 12 x .0025")	1
20-30005	30 cm x 30 cm x .13 mm (12 x 12 x .005")	1
20-30007	30 cm x 30 cm x .18 mm (12 x 12 x .007")	1
20-30010	30 cm x 30 cm x .25 mm (12 x 12 x .010")	1
20-30015	30 cm x 30 cm x .38 mm (12 x 12 x .015")	1
20-30020	30 cm x 30 cm x .50 mm (12 x 12 x .020")	1
20-30030	30 cm x 30 cm x .75 mm (12 x 12 x .030")	1
20-30040	30 cm x 30 cm x 1.0 mm (12 x 12 x .040")	1
20-30050	30 cm x 30 cm x 1.25 mm (12 x 12 x .050")	1
20-30060	30 cm x 30 cm x 1.5 mm (12 x 12 x .060")	1
20-30015R	30 cm x 30 cm x .38 mm (12 x 12 x .015") Reinforced	1
20-30020R	30 cm x 30 cm x .50 mm (12 x 12 x .020") Reinforced	1
20-30030R	30 cm x 30 cm x .75 mm (12 x 12 x .030") Reinforced	1
20-30040R	30 cm x 30 cm x 1.0 mm (12 x 12 x .040") Reinforced	1

MEDICAL GRADE SILICONE TUBING

Number	I.D. x O.D.	Length
NON-STERILE		
50-01101	0.012 x 0.025	50'
50-01111	0.020 x 0.037	50'
50-01121	0.025 x 0.047	50'
50-01131	0.030 x 0.065	50'
50-01141	0.040 x 0.085	50'
50-01151	0.058 x 0.077	50'
50-01161	0.062 x 0.095	50'
50-01171	0.062 x 0.125	50'
50-01181	0.078 x 0.125	50'
50-01191	0.104 x 0.192	50'
50-01201	0.118 x 0.181	50'
50-01211	0.125 x 0.250	50'
50-01221	0.132 x 0.183	50'
50-01231	0.157 x 0.257	50'
50-01241	0.188 x 0.313	50'
50-01251	0.188 x 0.375	50'
50-01261	0.250 x 0.375	50'
50-01271	0.250 x 0.438	50'
50-01281	0.250 x 0.500	50'

IMPLANTABLE GRADE SILICONE BLOCKS

- White
- Radiopaque

Number	A	B	C
SB-01	5.0 cm	3.0 cm	1.0 cm
SB-02	6.0 cm	4.0 cm	1.5 cm
SB-03	7.0 cm	5.0 cm	2.0 cm

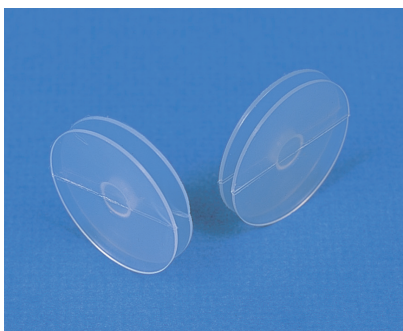

INVOTEC SEPTAL BUTTONS

- For non-surgical closure of nasal perforations
- Can reduce or eliminate crusting, epistaxis, and other symptoms of nasal perforations
- Soft 100% medical grade silicone for patient comfort and ease of insertion
- Provided sterile, ready to use
- Trim to size or custom sizes available upon request

Number	Description	Diameter	IFD	Post Ø	Qty/Box
20-10400	Nasal Septal Button	3.2 cm	2.5 mm	6 mm	1
20-10400S	Nasal Septal Button	5.0 cm	1.5 mm	8 mm	1

Reference: Kern, E.B., Facer, G.W., McDonald, T.J., Westood, W.B.

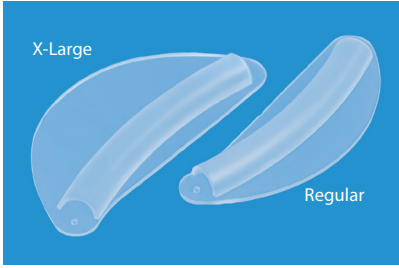
Closure of Nasal Septal Perforations with a Silastic Button: Results in 45 Patients. O.R.L. Digest, Vol. 39, July 1977.



BREATHE-EASY™ SPLINT

Silicone nasal septal splint with integral airway

- Provides septal support
- Allows nasal breathing post-operative through integral airway
- Pre-punched hole in anterior tip for easier suturing to prevent dislodgement and aid in septal stabilization
- 100% medical grade silicone for ease of insertion and removal
- Provided sterile, ready to use

Number	Description	Si ze	Dimensions	Height	Qty/Box
20-10500	Breathe-Easy Nasal Splint	Regular	70mm x 25mm	6 mm	5 pair
20-10500BSP	Breathe-Easy Nasal Splint	Regular	70mm x 25mm	6 mm	50 pair
20-10510	Breathe-Easy Nasal Splint	X-Large	88mm x 40mm	6 mm	5 pair

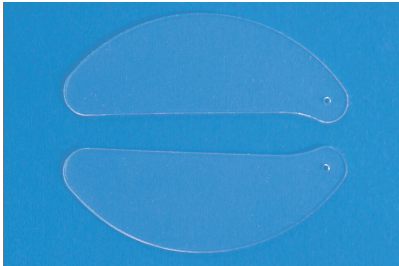

PRE-CUT™ SPLINT

Silicone nasal septal splint

- Provides septal support
- Pre-punched hole in anterior tip for easier suturing to prevent dislodgement and aid in septal stabilization
- 100% medical grade silicone for ease of insertion and removal
- Provided sterile, ready to use

Number	Description	Qty/Box
20-10505	Pre-Cut Nasal Splint	5 pair



DEMPSEY SPLINT

Fluoroplastic internal nasal splint

- 100% Fluoroplastic to reduce or prevent adhesions between the septum and lateral nasal wall by stabilizing the turbinates
- Easy insertion and removal
- Provided sterile, ready to use

Number	Description	Qty/Box
20-10602	Dempsey Medium	10 pair
20-10603	Dempsey Large	10 pair
20-10602C	Dempsey, Medium, Clear	10 pair
20-10603C	Dempsey, Large, Clear	10 pair

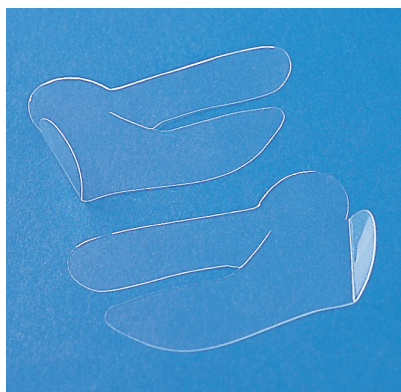
GUASTELLA/MANTOVANI™ INTERNAL NASAL SPLINT

- Designed for functional and/or aesthetic rhinosurgery of the septal valve nose tip and nasal pyramid
- Shaped to support the tip of the nose
- Made from 100% Fluoroplastic
- Packaged sterile, ready to use

Number	Description	Thickness	Qty/Box
20-10630	Guastella/Mantovani Internal Nasal Splint	.25mm	5 pair

Reference: Mantovani, M., Guastella, C., Mazzola, R.
 The Guastella/Montovani Septal-Valve Splint: An Intra-nasal
 Biplanar and Multivectorial Orthopedic Device
 Plastic and Reconstructive Surgery, Vol. 106, August, 2000

BIVALVE SPLINTS
Nasal Septal Splints

- 100% Fluoroplastic to reduce or prevent adhesions between the septum and lateral nasal wall
- Easy insertion and removal
- Pre-punched suture holes
- Over 30 years of clinical use
- Provided sterile and ready to use
- Sterile

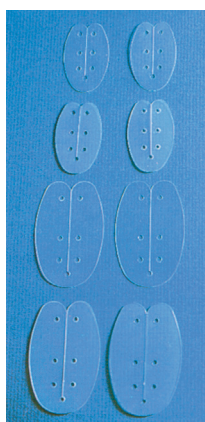

Number	Size	Description	Thickness	Qty/box
20-10650	Standard	Bivalve Splint	.25mm	5 pair
20-10650S	Standard	Bivalve Splint	.25mm	10 ea
20-10655	Standard	Bivalve Splint	.50mm	5 pair
20-10655S	Standard	Bivalve Splint	.50mm	10 ea
20-10660	Large	Bivalve Splint	.25mm	5 pair
20-10660S	Large	Bivalve Splint	.25mm	10 ea
20-10665	Large	Bivalve Splint	.50mm	5 pair
20-10665S	Large	Bivalve Splint	.50mm	10 ea

CUSTOM-CUT™ SPLINTS

- Choice of 100% Fluoroplastic or 100% medical grade silicone
- Allows for custom design by the surgeon
- Provided sterile and ready to use
- Five thicknesses available
- Sterile

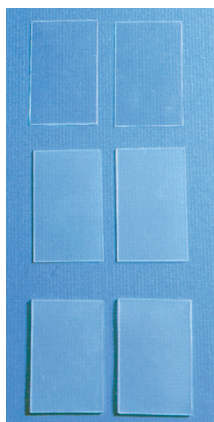

Number	Size	Description	Thickness	Qty/box
20-10670	38mm x 64mm	Custom-Cut Fluoroplastic	.25mm	5 pair
20-10675	38mm x 64mm	Custom-Cut Fluoroplastic	.50mm	5 pair
20-10680	55mm x 75mm	Custom-Cut Silicone	1.0mm	5 pair
20-10680S	55mm x 75mm	Custom-Cut Silicone	1.0mm	10 ea
20-10681	55mm x 75mm	Custom-Cut Silicone	.25mm	10 ea
20-10682	55mm x 75mm	Custom-Cut Silicone	.50mm	5 pair
20-10682S	55mm x 75mm	Custom-Cut Silicone	.50mm	10 ea
20-10685	38mm x 50mm	Custom-Cut Silicone	.13mm	10 ea
20-10685B	38mm x 50mm	Custom-Cut Silicone, Blue	.13mm	10 ea
20-10686	55mm x 75mm	Custom-Cut Silicone	1.5mm	5 pair
20-10686S	55mm x 75mm	Custom-Cut Silicone	1.5mm	10 ea



SOFT-FORM™ THERMOPLASTIC NASAL SPLINT

- Standard sizes or exclusive Invotec's Custom-Cut™ to design your own
- Easy to apply - adhesive backing

Number	Description			Qty/Box
20-10100	External Nasal Splint	small	single	10
20-10101	External Nasal Splint	small	kit	5 kits*
20-10110	External Nasal Splint	regular	single	10
20-10111	External Nasal Splint	regular	kit	5 kits*
20-10120	External Nasal Splint	custom-cut, 2 x 3 in	single	10
20-10121	External Nasal Splint	custom-cut, 2 x 3 in	kit	5 kits*
20-10125	Large Sheet	8.5 x 11 in	Cut to size	1
20-10130	External Nasal Splint	large	single	10
20-10131	External Nasal Splint	large	kit	5 kits*

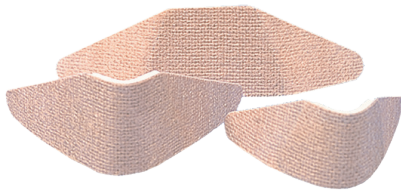

SOFT-FORM AL™ PADDED ALUMINUM NASAL SPLINT

- Easy to remove for patient comfort
- Three standard sizes
- Easy to apply - adhesive backing

Number	Description			Qty/Box
20-10200	External Nasal Splint	small	single	10
20-10201	External Nasal Splint	small	kit	5 kits*
20-10210	External Nasal Splint	regular	single	10
20-10211	External Nasal Splint	regular	kit	5 kits*
20-10220	External Nasal Splint	large	single	10
20-10221	External Nasal Splint	large	kit	5 kits*



SOFT-FORM AL-D™ PADDED ALUMINUM NASAL SPLINT

- Three standard sizes
- Easy to apply - adhesive backing

Number	Description			Qty/Box
20-10300	External Nasal Splint	small	single	10
20-10301	External Nasal Splint	small	kit	5 kits*
20-10310	External Nasal Splint	regular	single	10
20-10311	External Nasal Splint	regular	kit	5 kits*
20-10320	External Nasal Splint	large	single	10
20-10321	External Nasal Splint	large	kit	5 kits*



SOFT-FORM AL-B™ ALUMINUM NASAL SPLINT

- Two standard sizes

Number	Description			Qty/Box
20-10300B	External Nasal Splint	small	single	10
20-10310B	External Nasal Splint	medium	single	10

* Complete kits containing:

- (1) Sterile skin preparation sponge
- (1) Sterile alcohol sponge
- (1) Nasal Splint

- (1) Dorsum pad
- (6) Sterile 12mm x 100mm closure tapes



NASAL DRIP PADS

- Absorbs nasal drainage in the post-surgical recovery phase
- Eases the recovery process of any nasal surgery
- Ultra-absorbent
- User friendly
- Tape free

Number	Description	Qty/Box
600NDPN02015	Nasal Drip Pads, non sterile, with pre-affixed ear loops	10

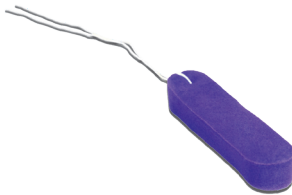

PVA+™ SPONGE PACKING

- Bacteriostatic agent inhibits the growth of bacteria* on the sponge for up to 7 days
- PVA+ helps reduce odor caused by bacteria compared to standard PVA
- Ideal for Nasal, Epistaxis or Sinus control
- Double compressed for easy insertion
- PVA+ is biocompatible, bacteriostatic, and very hydrophilic

Number	Description	Dimensions	Qty/Box
22-66400	PVA+ Nasal Dressing, Small	4.5 x 1.5 x 2 cm	10
22-66402	PVA+ Nasal Dressing, Large	8.0 x 1.5 x 2 cm	10
22-66406	PVA+ Epistaxis Dressing, Large	10 x 1.5 x 2.5 cm	10
22-66409	PVA+ Standard Nasal Dressing with Airway, Small	4.5 x 1.5 x 2.0 cm	10
22-66411	PVA+ Anatomical Nasal Tampon with Airway	8.0 x 1.5 x 3.0 cm	10
22-66413	PVA+ Anatomical Nasal Tampon	8.0 x 1.5 x 3.0 cm	10
22-66421	PVA+ Epistaxis Dressing, Small	5.5 x 1.5 x 2.5 cm	10
22-66426	PVA+ Sinus Dressing, Small	3.5 x 0.9 x 1.2 cm	10

*Yersinia Entercolitica, Serratia Mcrecesens and Bacillus Subtilis

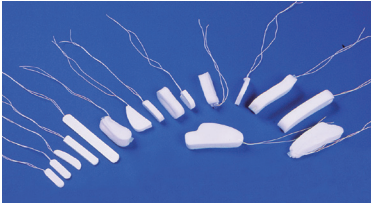

PVA SPONGE PACKING

- Soft, comfortable and conforming
- Packaged compressed and sterile
- Easily trimmed with scissors
- Small pore size minimizes tissue ingrowth

Standard

Invotec Number	Merocel® Number	Description	Dimensions	Qty/Box
22-60400	440400	Nasal Dressing, small	4.5 x 1.5 x 2.0 cm	10
22-60402	440402	Nasal Dressing, large	8.0 x 1.5 x 2.0 cm	10
22-60402P	400402	Nasal Dressing without string	8.0 x 1.5 x 2.0 cm	20
22-60409	440409	Nasal Dressing with airway, small	4.5 x 1.5 x 2.0 cm	10
22-60410	440410	Nasal Dressing, with airway, large	8.0 x 1.5 x 2.0 cm	10

Anatomical

22-60411	440411	Anatomical Nasal Tampon with airway	8.0 x 1.5 x 3.0 cm	10
22-60413	440413	Anatomical Nasal Tampon	8.0 x 1.5 x 3.0 cm	10
22-60414	440413	Slimline Anatomical Nasal Tampon	8.0 x .75 x 3.0 cm	10

Epistaxis Products

22-60406	440406	Posterior Epistaxis Tampon	10.0 x 1.5 x 2.5 cm	10
22-60406P	400406	Posterior Epistaxis Tampon without string	10.0 x 1.5 x 2.5 cm	10
22-60421	400421	Anterior Epistaxis Tampon	5.5 x 1.5 x 2.5 cm	10

Sinus Packs and Dressings

22-60426	400426	Sinus Dressing	3.5 x 0.9 x 1.2 cm	10 pair
22-60427	400427	Sinus Dressing	2.5 x 0.9 x 2.0 cm	10 pair
22-60530	400530	Sinus Dressing, slim	3.5 x 0.6 x 1.2 cm	10 pair



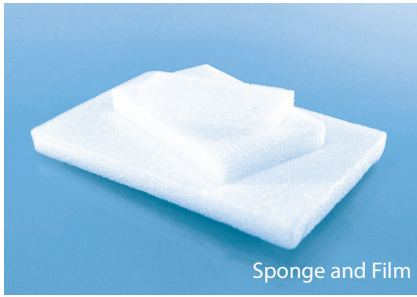

Sponge and Film



Powder



Cylinder

GELATIN SPONGES AND FILM USP

Indicated for use to control minimal bleeding by tamponade effect, blood absorption and platelet aggregation following ENT surgery and to prevent adhesions in the nasal cavity. Gelatin sponges are effective in supporting the new graft in the outer ear canal after tympanoplasty and buttressing middle ear implants.

Number	Description	Dimensions	Size		Qty/ Box
EQU60-20-07	EquiSpon® Sponge	60 x 20 x 7 mm	12-7	Sterile	10
EQU125-80-10	EquiSpon® Sponge	125 x 80 x 10 mm	100	Sterile	5
EQU125-80-01C	EquiSpon® Compressed Sponge	125 x 80 x 1 mm	100	Sterile	5
EQUF200-70-05	EquiSpon® Film	200 x 70 x 0.5 mm		Sterile	10
EQU80-50-10	EquiSpon® Sponge	80 x 50 x 10 mm	50	Sterile	10
EQU80-50-01C	EquiSpon® Compressed Sponge	80 x 50 x 1 mm	50	Sterile	10

POWDER

Number	Description		Qty/ Box
EQP-01	Equi-Spon® Powder, 1 gram	Sterile	4
EQP-01K	Equi-Spon® Hemostat Kit Includes: Two (2) 10 cc LL syringes, 18g needle, Flexible applicator cannula, 1gm Equi-Spon Porcine Powder with Mixing container	Sterile	5

GELATIN SPONGE TAMPON

Number	Description	Dimensions		Qty/ Box
EQU80-30-00	Gelatin Sponge, Fenestrated Cylinder	80 x 30 mm	Sterile	5



PureRegen™

Injectable Crosslinked Hyaluronic Acid Nasal Packing and Stent

PureRegen® injectable nasal packing is formulated to be used as a nasal dressing and stent, separating nasal structures following nasal and sinus surgical procedures.

PureRegen® bioresorbable nasal packing and stent is a non-pyrogenic, transparent, specifically formulated viscoelastic gel of self-cross-linked hyaluronan derived from nonanimal sources. This patented formulation ensures the material maintains the best possible stability during its storage and clinical use. Unlike esterified HA, PureRegen® Gel has not been reported as osteogenic in the nasal cavities.

PureRegen® Gel absorbs body fluids and blood resulting in its expansion gradually up to 50% by volume. The volume of the injected gel secures its initial stability within sinus cavity and controls minimal bleeding by tamponade effect.

- Controls minimal bleeding and oozing
- Clinically tested effective adhesion prevention
- Facilitates wound healing and functional mucociliary regeneration
- Provides moist wound environment
- Degradable - No need for painful traumatic removal
- Predictable retention - Gradually resorbs over 7-14 days

Number	Description	Qty/ Box
PR-00005	PureRegen™ gel 5 ml prefilled glass syringe with malleable cannula, sterile	1
PR00005L	Luer Syringe connector	10

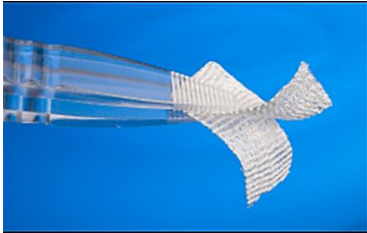

Equitamp® Gold is prepared by oxidizing a suitable form of cellulose, pure viscose. Additional processes are then performed to obtain a pure and high-quality form of oxidized and regenerated cellulose. Once placed against the tissue, Equitamp is fully resorbed, independent of the circumstances.

Mode of Application

Equitamp may be in dry form or after immersion in physiological saline. It must be pressed against the hemorrhage site. The gauze may remain in situ (after strict aseptic measures have been taken). The gauze completely decomposes with a week or may be discharged by natural means.

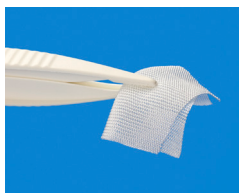

Ordering Information

Equitamp has a density of 120 mg/cm² and a thickness of 0.4mm.

Catalog No.	Description	QTY/Box
ETK-07-10	Equitamp Knitted oxidized regenerated cellulose gauze, 10cm x 7.5cm (3x4")	10
ETG-05-035	Equitamp Gold oxidized regenerated cellulose gauze, 5cm x 35cm (2x14")	10
ETG-10-020	Equitamp Gold oxidized regenerated cellulose gauze, 10cm x 20cm (4x8")	10
ETG-05-075	Equitamp Gold oxidized regenerated cellulose gauze, 5cm x 7.5cm (2x3")	20
ETG-05-125	Equitamp Gold oxidized regenerated cellulose gauze, 5cm x 1.25 cm (2x0.5")	20
ETF-25-05	Equitamp Fibrillar 7 layers non-woven Oxidised Regenerated Cellulose 2.5 x 5.0 cm (1 x 2")	10
ETF-05-10	Equitamp Fibrillar 7 layers non-woven Oxidised Regenerated Cellulose 5.0 x 10 cm (2 x 4")	5
ETF-10-10	Equitamp Fibrillar 7 layers non-woven Oxidised Regenerated Cellulose 10 x 10 cm (4 x 4")	5

Features

- Sterile
- Open woven structure
- Shelf life 5 years post production
- Fast hemostatic effect (2 to 4 minutes)
- Fully resorbable by means of enzymatic resorption and hydrolysis.
- Resorption time 4-6 days in contact with blood.
- No tissue reaction and no hypersensitivity
- Maximum tensile strength and easy to handle
- Independently proven bactericidal against MRSA, MRSE, VRE and PRSP

Indication – Hemostatic Mechanism

Equitamp is used adjunctively in surgical procedures to assist in the control of capillary, venous, and small hemorrhages when ligation or other conventional methods are impractical or ineffective. With Equitamp, hemostasis is achieved within a few minutes. Equitamp can be cut to size for use in endoscopic procedures.

When Equitamp comes into contact with blood, it will absorb the blood and gradually swell, eventually dissolving into a gelatinous material. By briefly applying pressure, the material will adhere to the wound, effectively sealing the ends of the venous capillaries and resulting in mechanical hemostatic effect.

The coagulation cascade is activated, transforming soluble fibrinogen into a net of insoluble fibrin which stops the “bleeding”.

Under normal circumstances, Equitamp is completely bio-absorbable and should be resorbed in 4-6 days. Equitamp should be completely absorbed within 30 days.

In addition to its local hemostatic qualities, Equitamp, has an acidic pH value, pH = 5.5-6.0, and is a proven bactericide, in vitro, against a wide range of gram positive and gram negative organisms, including aerobes and anaerobes. The gauze is proven not to inactivate thrombin.

After 24 hours, a log 7 reduction of these microorganisms is reported.

- Methicillin-Resistant Staphylococcus aureus (MRSA)
- Methicillin-Resistant Staphylococcus epidermis (MRSE)
- Vancomycin-Resistant Enterococci faecium (VRE)
- Penicillin-Resistant Streptococcus Pneumonia (PRSP)

Equitamp is not an alternative to specifically designed systemically applied antimicrobial agents.

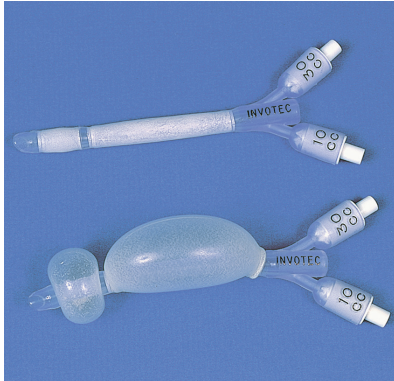

ULTRA-STAT™

Epistaxis nasal balloon with integral airway

- Designed for fast control of intra-nasal bleeding and patient comfort
- Bevelled posterior tip and soft silicone construction provide for easy placement
- Two silicone balloons independently filled facilitate pressure control in both the anterior and posterior chambers
- 100% soft medical grade silicone for patient comfort when inserting
- Integral airway allows for nasal breathing
- Silicone construction prevents adhesion for easy removal
- Provided sterile with or without inflation syringe

Number	Description		Qty/Box
20-10700	Ultra-Stat Epistaxis Balloon with syringe	Sterile	1
20-10701	Ultra-Stat Epistaxis Balloon	Sterile	1

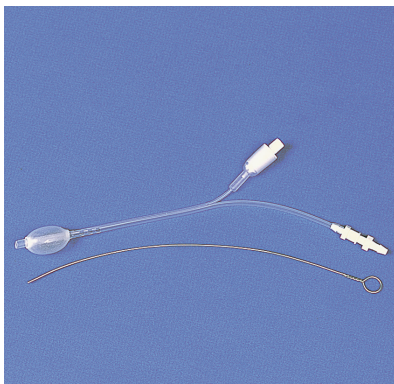

POST-STAT™

Posterior nasal packing and suction channel

- Excellent for control of posterior intra-nasal bleeding
- Low profile design to maximize working space
- Multi-port suction/irrigator catheter inhibits clogging and provides for clear working area
- Soft silicone construction provides for low cuff pressure
- Silicone construction prevents adhesion for easy removal
- Provided sterile with inflation syringe

Number	Description		Qty/Box
20-10710	Post-Stat Epistaxis Balloon with syringe	Sterile	1



QUICK-PACK™

With airway

- Designed for nasal packing following septal, rhinoplasty, or other intra-nasal procedures
- 100% medical grade silicone reduces or prevents adhesion allowing for patient comfort in use and during removal
- Integral airway allows for nasal breathing
- Provided sterile with inflation syringe

Number	Description		Qty/Box
20-10715	Quick-Pack Nasal Packing with syringe	Sterile	2



Number	Description			Qty/Box
65-8900	Spear Tip with handle	Angled	Sterile	4
65-8920	Sickle Tip with handle	Straight	Sterile	4
65-9610	Uncinate with handle		Sterile	4



Number	Description			Qty/Box
65-6001	Septotome	Angled 90°	Sterile	6

DISPOSABLE SUCTIONS

R&CS ACC

DIS

OTO ACC

OSS

LAR ACC

SPE ACC

RHI INS

PSB

OTO INS

LAR INS

ORG/NAS INS

HANDLES

HOUSE/HOUGH STYLE HANDLE

- Used as a connector between the suction tip and the suction tubing
- Sterile, packaged in individual peel pouch



Rhinologic / Otologic

Number	Description	Qty/Box
66500992	Suction Controller, black	20
66505009	Suction Tip Handle with integral bending slots, without finger control	20
66500990	Elongated House/Hough style handle with finger control hole, 3"	10



Otologic

Number	Description	Non-sterile	Qty/Box
NZ3238-100	Suction controller, black, with finger hole	Non-sterile	100

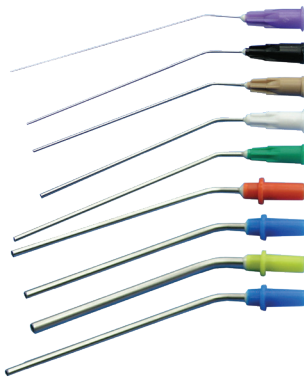

METAL SUCTION TIP

- Applicable for ear examinations, suction of wax and other fluids, paracentesis
- The curved angle is specially designed for microscopic examination and surgery
- Quick connector suction tip handle is easy to change during surgery
- Sterile, packaged in individual peel pouch
- Available in broad variety of lumen sizes

Rhinologic

Number	Description	Color	Qty/Box
65000045	0.4mm x 80mm	Lilac	20
66500072	0.7mm x 80mm	Black	20
66500100	1.0mm x 70mm, 3 Fr	Brown	20
66500102	1.4mm x 80mm, 4 Fr	Brown	20
66500140	1.4mm x 70mm, 4 Fr	White	20
66500142	1.4mm x 80mm, 4 Fr	White	20
66500200	2.0mm x 80mm, 14 g, 6 Fr	Green	20
66500250	2.5mm x 80mm, 7.5 Fr	Orange	20
66500300	3.0mm x 80mm, 9 Fr	Blue	20
66500400	4.0mm x 80mm, 12 Fr	Yellow	20
66509100	1.4mm x 100mm, 3 Fr	Brown	20
66509140	1.4mm x 100mm, 4 Fr	White	20
66509200	2.0mm x 100mm, 6 Fr	Green	20
66509250	2.5mm x 100mm, 7 Fr	Orange	20
66509300	3.0mm x 100mm, 9 Fr	Blue	20
66516020	2.0mm x 150mm, 6 Fr	Green	10
66516030	3.0mm x 150mm, 9 Fr	Blue	10
66516040	4.0mm x 150mm, 12 Fr	Yellow	10

DIS

ROSEN-HOUSE STYLE SUCTION NEEDLE

Number	Description	Dimensions	Color	Qty/Box
66500040	Micro suction tip	0.4mm x 70mm, 26 G	Lilac	20
66500045	Micro suction tip	0.4mm x 80mm, 26 G	Lilac	20
66500070	Micro suction tip	0.7mm x 70mm, 22 G	Black	20
66500072	Micro suction tip	0.7mm x 80mm, 22 G	Black	20
66500100	Micro suction tip	1.0mm x 70mm, 20 G, 3 Fr	Brown	20
66500140	Micro suction tip	1.4mm x 70mm, 18 G, 4 Fr	White	20
66500208	Suction tip	2.0mm x 70mm, 14G, 5 Fr	Green	20
66500250	Suction tip	2.5mm x 80mm, 7 Fr	Orange	20
66500300	Micro Suction tip	3.0mm x 80mm, 9 Fr	Blue	20

FRAZIER/FERGUSON NASAL STYLE SUCTION

- Designed for Rhinology surgery or examination
- Suction tip made of medical grade stainless steel
- Sterile, packed in individual peel pouch
- Available with one side hole (velvet eye) at tip end to avoid biopsy effect (tissue damage)

Number	Description / Dimensions	Color	Qty/Box
66501020	2.0mm x 150mm, 6 Fr	Clear	10
66501030	3.0mm x 150mm, 9 Fr	Clear	10
66501040	4.0mm x 140mm, 12 Fr	Clear	10
66511020	2.0mm x 150mm, 6 Fr with side hole	Clear	10
66511030	3.0mm x 150mm, 9 Fr with side hole	Clear	10
66511040	4.0mm x 150mm, 12 Fr with side hole	Clear	10

V. EICKEN SINUS ANTRUM CANNULA, LONG CURVE

- FESS procedures
- Olive ball tip for atraumatic dissection or removal of synechia
- Pencil grip
- Sterile

Number	Description	Dimensions	Color	Qty/Box
66503020	SS Olive Tip Suction	2.0mm x 150mm, 6", long curve	Clear	10
66503025	SS Olive Tip Suction	2.5mm x 150mm, 6", long curve	Clear	10
66503030	SS Olive Tip Suction	3.0mm x 150mm, 6", long curve	Clear	10
66503035	SS Olive Tip Suction	3.5mm x 150mm, 6", long curve	Clear	10
66503040	SS Olive Tip Suction	4.0mm x 150mm, 6", long curve	Clear	10

OTOLOGY

ACCESSORIES

R&CS ACC

DIS

OTO ACC

OSS

LAR ACC

SPE ACC

RHI INS

PSB

OTO INS

LAR INS

ORG/NAS INS



EAR PROTECTOR KITS

- Lightweight yet stable, will not slide
- Easy application with adjustable velcro straps
- Comfortable - Exerts even, consistent pressure
- Latex-free and sterile

Number	Description		Qty/Box
90-11000	Hard Ear Dressing Kit - adult size Includes: 10 - 4 x 4" gauze sponges, 1 Telfa™ pad	Sterile	10 kits
90-15005	Soft Ear Dressing Kit Includes: 4 - 4 x 4" gauze sponges, 1 Telfa™ pad	Sterile	10 kits

MALLEABLE EAR DRESSINGS

- Ultra-thin, non-rigid
- Smooth, non-adherent silicone surface with a thin malleable metallic layer
- Provides gentle tamponade pressure and minimizes removal discomfort
- As suggested by Frederick Godley, MD, Providence, RI



Number	Description	Qty/Box
90-20000	Malleable ear compression dressing	10

- Provides gentle tamponade pressure
- A rigid bandage that can conform to and retain the shape of the external ear
- As suggested by Frederick Godley, MD, Providence, RI



90-21000	Thermoplastic ear compression dressing/splint	5
----------	---	---

OTOLOGY PACKING STRIPS

- Designed to protect the tympanic membrane following middle ear surgery
- Available in blue to provide greater visibility in the ear canal
- Rosette packing
- Provided sterile, 3 per pack

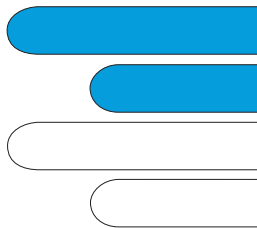

Number	Description	Dimensions	Qty/Box
27-10000	Clear silicone	6 x 20 x 0.13 mm	30
27-10000B	Blue silicone	6 x 20 x 0.13 mm	30
27-10001	Clear silicone	6 x 40 x 0.13 mm	30
27-10001B	Blue silicone	6 x 40 x 0.13 mm	30
20-10685	Clear silicone sheeting	38 x 50 x 0.13 mm	10
20-10685B	Blue silicone sheeting	38 x 50 x 0.13 mm	10

For a complete line of silicone sheeting available see Sheeting and Tubing.

EAR WICKS

- PVA ear packs are soft, comfortable, conforming, absorbs quickly and expands evenly
- Packaged compressed and sterile



Number	Description	Dimensions	Qty/Box
22-60108	Ear Wick	9 mm x 15 mm	20
22-65108	Ear Wick	9 mm x 15 mm	50
22-60110	Ear Wick - long	9 mm x 24 mm	20
22-65110	Ear Wick - long	9 mm x 24 mm	50
22-60108F	Ear Wick, Fenestrated	9 mm x 15 mm	20
22-65108F	Ear Wick, Fenestrated	9 mm x 15 mm	50
22-60110F	Ear Wick - long, Fenestrated	9 mm x 24 mm	20
22-65110F	Ear Wick - long, Fenestrated	9 mm x 24 mm	50

BURS

- Designed for use with straight shank drill systems and Xomed® power hand pieces
- Provided sterile

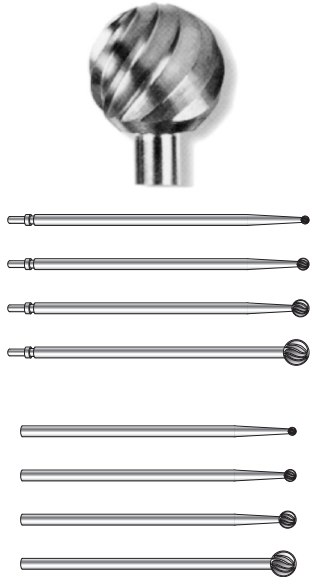
Round Carbide

Number w/ Notch	w/o Notch	Head Diameter (mm)	Length (mm)	Number of Flutes
BC-70050	BC-70050P	0.5	70	4
BC-70100	BC-70100P	1.0	70	6
BC-70150	BC-70150P	1.5	70	6
BC-70200	BC-70200P	2.0	70	6
BC-70250	BC-70250P	2.5	70	6
BC-70300	BC-70300P	3.0	70	8
BC-70350	BC-70350P	3.5	70	8
BC-70400	BC-70400P	4.0	70	8
BC-70450	BC-70450P	4.5	70	10
BC-70500	BC-70500P	5.0	70	10
BC-70550	BC-70550P	5.5	70	10
BC-70600	BC-70600P	6.0	70	10
BC-70650	BC-70650P	6.5	70	10
BC-70700	BC-70700P	7.0	70	12
BC-70000	BC-70000P	Complete Set - one of each		

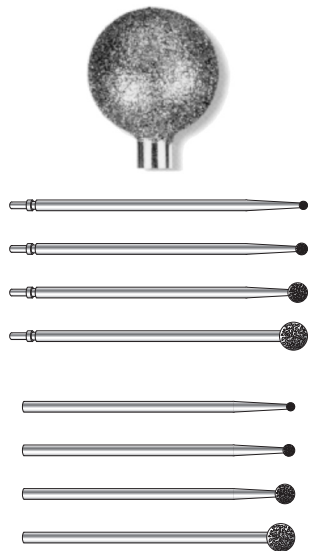
Round Diamond Bur

Number w/ Notch	w/o Notch	Head Diameter (mm)	Length (mm)	Style
BD-70050	BD-70050P	0.5	70	Diamond
BD-70100	BD-70100P	1.0	70	Diamond
BD-70150	BD-70150P	1.5	70	Diamond
BD-70200	BD-70200P	2.0	70	Diamond
BD-70250	BD-70250P	2.5	70	Diamond
BD-70300	BD-70300P	3.0	70	Diamond
BD-70350	BD-70350P	3.5	70	Diamond
BD-70400	BD-70400P	4.0	70	Diamond
BD-70500	BD-70500P	5.0	70	Diamond
BD-70600	BD-70600P	6.0	70	Diamond
BD-70000	BD-70000P	Complete Set - one of each		
O225300		Bur Rack - Holds 34 straight shaft burs, length 70 mm		

MYRINGOTOMY MICRO BLADES, TAPERED SHAFT

• Sterile



Number	Description	Qty/Box
60-08230	Micro Otologic Blade Upcutting Angled	6
60-08231	Micro Otologic Blade Downcutting Angled	6
60-08232	Micro Otologic Blade Razor Straight shank	6
60-08233	Micro Otologic Blade Spear Angled	6
60-08234	Micro Otologic Blade Spear Straight shank	6
60-44820	Stainless steel handle for tapered blades	1

MYRINGOTOMY KNIVES AND BLADES, FLAT SHAFT ANGLED

• Sterile



Number	Description	Qty/Box
60-45010	Lance Adult Down cut	6
60-45020	Lance w/ handle Adult Down cut	6
60-45030	Lance Adult Up cut	6
60-45040	Lance Pediatric Down cut	6
60-45050	Lance with handle Pediatric Down cut	6
60-45070	Spear Pediatric	6
60-45080	Spear with handle Pediatric	6

MULTI-USE MYRINGOTOMY KNIVES WITH PROTECTIVE CAP

• Non-sterile, Auto-clavable

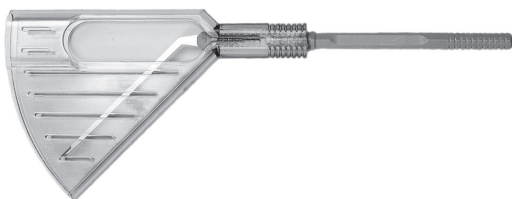

Number	Description	Qty/Box
34-2123	Lance up cut	3
34-2124	Lance down cut	3

TYMPANOPLASTY BLADES

• Sterile



Number	Description	Qty/Box
60-46080	Tympanoplasty angled	6
60-46090	Tympanoplasty straight	6
60-46100	Sickle blade	6

SPECIALTY MINI BLADES

• Sterile



Number	Description	Qty/Box
65-6400	Round tip sharp	12
65-6500	15° pointed	12
65-6600	Lamellar blade straight	6
65-6900	Straight 180° cutting surface	6

MYRINGOTOMY KNIVES AND BLADES, ROUND SHAFT

- Sterile



Number	Description			Qty/Box
60-44010	Lance	Straight shaft	Adult	6
60-44015	Lance	Angled shaft	Adult	6
60-44020	Lance w/ handle	Straight shaft	Adult	6
60-44025	Lance w/ handle	Angled shaft	Adult	6
60-44040	Lance on round handle	Straight shaft	Pediatric	6
60-44045	Lance on round handle	Angled shaft	Pediatric	6
60-44046	Lance on round handle	Angled shaft	Pediatric	6
60-40716	Lance w/ flat black handle	Straight shaft		6
60-40716BSP	Lance w/ flat black handle	Straight shaft		100
60-40715	Sickle w/ flat black handle	Straight shaft		6
60-45090	Sickle knife	Straight shaft		6

STAINLESS STEEL CHUCK STYLE HANDLES

- Non-Sterile



Number	Description			Qty/Box
60-44200	Stainless steel handle for flat stock knives	10 cm		1
60-44210	Stainless steel handle for round stock knives	10 cm		1
60-44820	Stainless steel handle for tapered knives			1
60-44201	Replacement collet for handle #60-44200			1

EAR CURETTE

- Non-Sterile
- Carbon fiber filled nylon



Number	Description		Qty/Box
NZ3431-100	Ear Curette	3mm loop	100
NZ3432-100	Ear Curette	2.5mm loop	100
NZ3441-100	Cerumen Hook, non-sterile		100
NZ3461-100	Rosen needle, slight curve		100

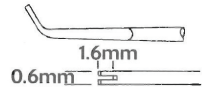

- Reusable
- Duberstein Type

Number	Description	Length	Tynes	Qty/Box
O99610	Round handle, stainless, matt	15.7 cm	0.63 mm x 1.57 mm	1

INVOTEC EAR SPECULA

- New oval design of the cone and oblique cut end for improved line of sight
- New, wider, rim on the grip side for better stability when hand held
- For examination procedures
- Fits Peter's or Siegler's pneumatic otoscopes
- Hygienically packed
- Latex and PVC-free

Number	Description	Qty/Box
Sterile		
606625S	2.5 mm specula	10
606640S	4 mm specula	10
606650S	5 mm specula	10
606660S	6 mm specula	10
606680S	8 mm specula	10
Non-Sterile		
606625	2.5 mm specula	20
606630	3.0 mm specula	20
606640	4 mm specula	20
606650	5 mm specula	20
606660	6 mm specula	20
606680	8mm specula	20

DISPOSABLE MYRINGOTOMY KIT

- A ready made kit for Paracentesis Surgery
- Sterile, single-use

Number	Description	Qty/Box
NZ3246-5	Myringotomy Kit: (1) Myringotomy Knife, (1) Jobson Home Probe, (1) Rosen Inserter, (2) Bent suction tubes -16g and 20g, (1) Suction controller, (3) Specula - 4 mm, 5 mm, and 6 mm.	5
	Myringotomy Kit with 8 cm Forceps: (1) Myringotomy Knife, (1) Jobson Home Probe, (1) Rosen Inserter, (2) Bent suction tubes -16g and 20g, (1) Suction controller, (3) Specula - 4 mm, 5 mm, and 6 mm, (1) Forceps - Stainless Steel - 7, Jaw.	
NZ3270-5	Myringotomy Kit with Stainless Steel Forceps: (1) Myringotomy Knife, (1) Jobson Home Probe, (1) Rosen Inserter, (2) Bent suction tubes -16g and 20g, (1) Suction controller, (3) Specula - 4 mm, 5 mm, and 6 mm, (1) Forceps - Stainless Steel - 3.5 mm, Jaw.	5
NZ3271B-5	Pediatrics Myringotomy Kit: (1) Myringotomy Knife, (1) Jobson Home Probe - Oval, (1) Rosen Inserter, (2) Bent suction tubes -16g and 18g, (1) Suction controller, (3) Ear Specula - 3 mm, 4 mm, and 5 mm, (1) Forceps - Stainless Steel - Ultra fine.	5



ARMSTRONG GROMMET

Number	Description	Material	ID	Qty/Box
23-50800	Armstrong Grommet	Sterile Silicone	1.14mm	10



MODIFIED ARMSTRONG GROMMET

Number	Description	Material	ID	Qty/Box
23-40810	Modified Armstrong Grommet	Sterile FLPL	1.14mm	10
23-40820	Modified Armstrong Grommet	Sterile FLPL	1.14mm	10

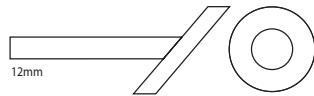

ARMSTRONG STRAIGHT SHANK

Number	Description	Material	ID	Qty/Box
23-50801	Armstrong Straight Shank	Sterile Silicone	1.14mm	10



BAXTER BUTTON

Number	Description	Material	ID	Qty/Box
23-41300	Tapered Lumen	Sterile FLPL	1.27mm	10
23-41300B	Tapered Lumen, Blue	Sterile FLPL	1.27mm	10

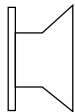

BEVELED BOBBIN

Number	Description	Material	ID	Qty/Box
23-41310	Beveled Bobbin	Sterile FLPL	1.14mm	10

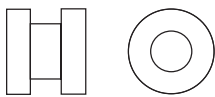

DONALDSON STYLE

Number	Description	Material	ID	Qty/Box
23-40200	Donaldson Grommet	Sterile FLPL	1.14mm	10
23-40201	Donaldson Grommet with wire	Sterile FLPL	1.14mm	10
23-50200	Donaldson Grommet with tab	Sterile Silicone	1.14mm	10
23-50210	Donaldson Grommet without tab	Sterile Silicone	1.14mm	10



MINI TEF FLUOROPLASTIC

Number	Description	Material	ID	Qty/Box
23-42076	Invotec Tiny Tef	Sterile FLPL	0.76mm	10

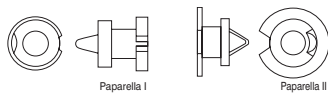

PAPARELLA STYLE

Number	Description	Material	ID	Qty/Box
23-50700	Paperella I	Sterile Silicone	1.00mm	10
23-50720	Paperella I	Sterile Silicone	1.14mm	10
23-50710	Paperella II	Sterile Silicone	1.50mm	10

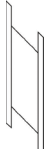

POPE BEVELED GROMMET

Number	Description	Material	ID	Qty/Box
23-41800	Angled Flanges, Blue	Sterile PE	1.14 mm	10



REUTER BOBBIN STYLE

Number	Description	Material	ID	Qty/Box
23-40400	Reuter Bobbin	Sterile FLPL	1.14 mm	10
23-40400B	Reuter Bobbin - Blue	Sterile FLPL	1.14 mm	10
23-40401	Reuter Bobbin with wire	Sterile FLPL	1.14 mm	10
23-40420	Reuter Bobbin	Sterile FLPL	1.02 mm	10
23-60400	Reuter Bobbin	Sterile Titanium	1.14 mm	10
23-60401	Reuter Bobbin with wire	Sterile Titanium	1.14 mm	10
23-60427	Reuter Bobbin	Sterile Titanium	1.27 mm	10
23-61401	Reuter Bobbin	Sterile Titanium	1.09 mm	10

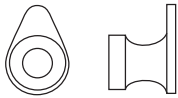

SHAH STYLE

Number	Description	Material	ID	Qty/Box
23-40500	Shah Grommet	Sterile FLPL	1.14 mm	10
23-40501	Shah Grommet with wire	Sterile FLPL	1.14 mm	10

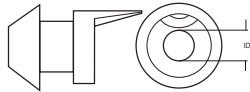

SHEA PARASOL VENT TUBE

Number	Description	Material	ID	Qty/Box
23-50536	Shea Parasol with tab	Sterile Silicone	1.02 mm	10

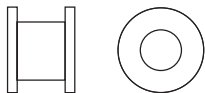

SHEEHY COLLAR BUTTON

Number	Description	Material	ID	Qty/Box
10076	Sheehy Collar Button	Sterile Titanium	0.76 mm	10
10100	Sheehy Collar Button	Sterile Titanium	1.0 mm	10
10100-F	Sheehy Collar Button	Sterile Titanium	1.0 mm	10
10125	Sheehy Collar Button	Sterile Titanium	1.25 mm	10
10125-F	Sheehy Collar Button	Sterile Titanium	1.25 mm	10
10150	Sheehy Collar Button	Sterile Titanium	1.50mm	10
10150-F	Sheehy Collar Button	Sterile Titanium	1.50mm	10
23-40300	Sheehy Collar Button	Sterile FLPL	1.27mm	10
23-40300B	Sheehy Collar Button - Blue	Sterile FLPL	1.27mm	10
23-40301	Sheehy Collar Button with wire	Sterile FLPL	1.27mm	10
23-50300	Sheehy Collar Button	Sterile Silicone	1.27mm	10

SHEPARD STYLE GROMMET

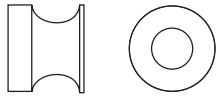

Number	Description	Material	ID	Qty/Box
23-40100-S	Shepard Grommet	Sterile FLPL	1.14 mm	10
23-40100-SB	Shepard Grommet - Blue	Sterile FLPL	1.14 mm	10
23-40101-S	Shepard Grommet with wire	Sterile FLPL	1.14 mm	10
23-40101-SB	Shepard Grommet with wire - Blue	Sterile FLPL	1.14 mm	10
101100	Shepard Grommet	Sterile Titanium	1.0 mm	10
101100-F	Shepard Grommet with wire	Sterile Titanium	1.0 mm	10
101125	Shepard Grommet	Sterile Titanium	1.25 mm	10
101125-F	Shepard Grommet with wire	Sterile Titanium	1.25 mm	10
23-40120	Shepard Grommet	Sterile FLPL	1.02 mm	10
23-40121	Shepard Grommet with wire	Sterile FLPL	1.02 mm	10

SPOON BOBBIN STYLE



Number	Description	Material	ID	Qty/Box
23-60500	Spoon Bobbin	Sterile Titanium	1.14 mm	10

STRAIGHT SHANK VENT TUBE

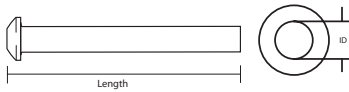

Number	Description	Material	ID	Length	Qty/Box
23-41100	Straight Shank Vent Tube	Sterile FLPL	.089 mm	12 mm	10
23-41110	Straight Shank Vent Tube	Sterile FLPL	1.14 mm	12 mm	10
23-41120	Straight Shank Vent Tube	Sterile FLPL	.089 mm	7 mm	10
23-41130	Straight Shank Vent Tube	Sterile FLPL	1.14 mm	7 mm	10

T-TUBES

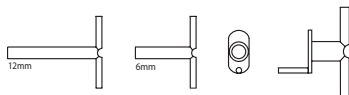

Number	Description	Material	ID	Qty/Box
23-50600	T-Tube	Sterile Silicone	1.14 mm	10
23-50601	T-Tube Modified	Sterile Silicone	1.32 mm	10
23-50610	T-Grommet	Sterile Silicone	1.14 mm	10

ULTRA VENT

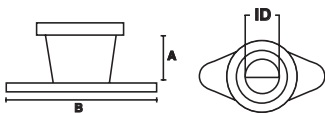

Number	Description	Material	ID	Qty/Box
23-50900	A=1.37 mm, B=4.5 mm	Sterile Silicone	1.27 mm	10

OTOVENT® MIDDLE EAR AUTO INFLATION SYSTEM

Otovent can prevent or treat Otitis Media and be an attractive alternative to surgery. Otovent treats many of the complications associated with negative ear pressure caused by Eustachian tube dysfunction.



- Frequent treatments are painless and regarded as “fun” by children
- Typically satisfying results early on; compliance is very high
- Effective without drugs and with no known side effects
- May avoid or delay recourse to surgery or ventilation tubes
- Very low treatment cost

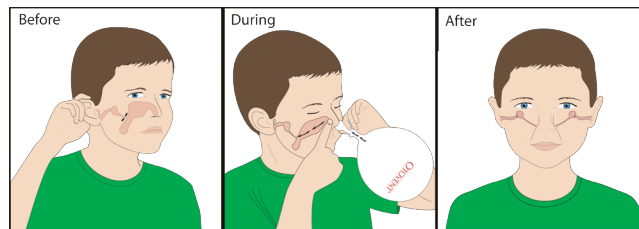

BEFORE: Otitis Media, Eustachian tube dysfunction Negative pressure, pain, impaired hearing, learning problems.

DURING: Controlled pressure is transmitted through the nose and Eustachian tube to the middle ear pressure is balanced.

AFTER: Pain relief, hearing restored and improved prognosis.

OTOVENT TREATMENT SET

Each Kit Contains: one nose piece made of PVC, one instruction leaflet, and 10 pressure tested latex balloons

Number	Description	Qty/Box
90-00000	Otovent Kits, 1 Case*	12 patient kits
90-00001	Otovent Kits, 1/2 Case*	6 patient kits
90-00000B	Otovent balloons*	5 per pack

* Contains latex

OSSICULAR PROSTHESES

R&CS ACC

DIS

OTO ACC

OSS

LAR ACC

SPE ACC

RHI INS

PSB

OTO INS

LAR INS

ORONAS INS

L = Total Length
FL = Functional Length

DENSE HA INCUS STRUT

• Columella O.D.: 2.00

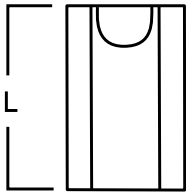

Number	Length (MM)
INCUS 07.17.275C	2.75
INCUS 07.17.325C	3.25
INCUS 07.17.375C	3.75
INCUS07.17.490C	4.90

TITANIUM INCUS STRUT

• Columella O.D.: 2.00 / Columella I.D.: 1.20

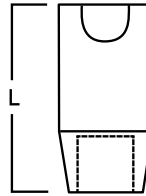

Number	Length (MM)
PAP 07.56.300	3.00
PAP 07.56.400	4.00
PAP 07.56.500	5.00

DENSE HA PARTIAL INCUS ISJ

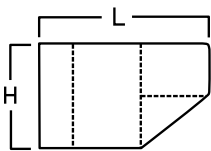

Number	Dimensions
INCUS 07.32	L = 2.50 mm H = 1.60 mm

TITANIUM INCUS GRIP REPLACEMENT

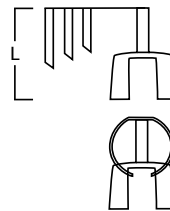

Number	Dimensions
PAP 07.53	Total length: 1.90 mm Thickness: 0.05 mm

POROUS HA ADJUSTABLE PARTIAL WITH MALLEUS SLOT

• Platinum wire
• Columella O.D.: 2.10

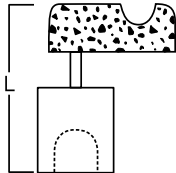

Number	L (MM)	Number	L (MM)
PAP 07.34.400	4.00	PAP 07.34.550	5.50
PAP 07.34.450	4.50	PAP 07.34.600	6.00
PAP 07.34.500	5.00		

DENSE HA AND PE INCUS REPLACEMENT WITH MALLEABLE HEAD

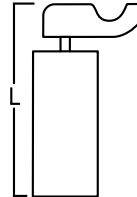

Number	Dimensions
PAP 07.43	Total Length (L): 6.50 mm Head: 3.50 Platinum wire O.D.: 0.25 Columella external O.D.: 2.20

POROUS HA HEAD WITH MALLEUS SLOT, PTFE SHAFT

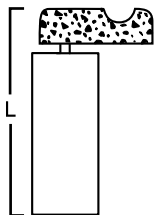

Number	Dimensions
PAP 07.36	Total Length (L): 6.50 to 3.00 mm Head O.D.: 3.50 mm Platinum Wire O.D.: 0.25 mm PTFE Columella O.D.: 2.10 mm

POROUS HA AND PE ADJUSTABLE PARTIAL WITH MALLEUS SLOT

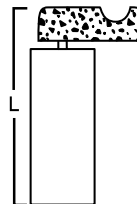

Number	Dimensions
PAP 07.38	Total Length (L): 6.50 to 3.00 mm Head O.D.: 3.50 mm Platinum Wire O.D.: 0.25 mm Audio-PE Columella O.D.: 2.10 mm

POROUS HA / PTFE / TITANIUM UNIVERSAL TOTAL/PARTIAL WITH MALLEUS HOOK

• Columella inside O.D.: 1.10

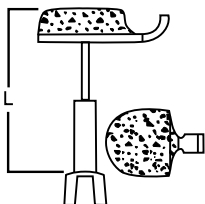

Number	Dimensions
TPL 07.59	Partial: Minimum Length: 3.50 Columella outside O.D.: 1.30 Total: Maximum length: 7.50 Columella O.D.: 0.60

L = Total Length
FL = Functional Length

POROUS HA / TITANIUM INCUS WITH MALLEUS SLOT

• Columella O.D.: 1.30 / Columella I.D.: 1.10

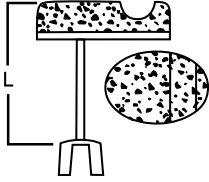

Number	L (MM)	Number	L (MM)
PAP 07.66.175	1.75	PAP 07.66.325	3.25
PAP 07.66.200	2.00	PAP 07.66.350	3.50
PAP 07.66.225	2.25	PAP 07.66.400	4.00
PAP 07.66.250	2.50	PAP 07.66.450	4.50
PAP 07.66.275	2.75	PAP 07.66.500	5.00
PAP 07.66.300	3.00		

POROUS HA / TITANIUM EXTENSIBLE INCUS WITH MALLEUS SLOT

• Extendable Stem

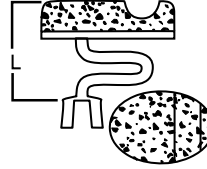

Number	Dimensions
PAP 07.68	Total Length (L): 2.50 to 5.00 mm Head size: 3.50 x 2.50 mm

POROUS HA / TITANIUM INCUS WITH MALLEUS SLOT

• Columella O.D.: 1.30 / Columella I.D.: 1.10

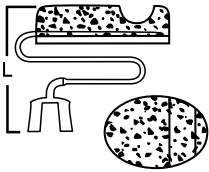

Number	Extended L (MM)	Compressed L (MM)
PAP 07.60.250	2.50	1.80
PAP 07.60.300	3.00	2.30
PAP 07.60.350	3.50	2.80
PAP 07.60.400	4.00	3.30
PAP 07.60.450	4.50	3.80
PAP 07.60.500	5.00	4.30

POROUS HA / TITANIUM REPLACEMENT INCUS WITH MALLEUS SLOT

• Extendable Stem

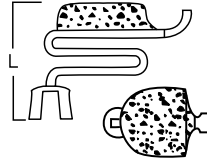

Number	Length
PAP 07.72	2.0 to 5.0 mm

L = Total Length
FL = Functional Length

TITANIUM/PTFE TRIMMABLE INCUS STAPES

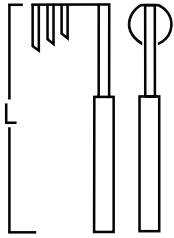

Number	Dimensions
TAP 07.52	Total Length: 6.25 to 4.50 mm Titanium F67 Gr.2 Thickness: 0.05 mm PTFE O.D.: 0.60 mm

DENSE HA I-S "MARPLA" BY E. GARCIA IBANEZ - WEHRS TYPE

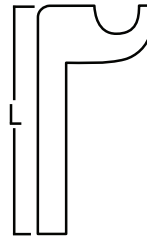

Number	Dimensions
TAP 07.54	Total Length: 8.00 mm Head: 4.00 mm Columella width: 1.00 x 0.80 mm

DENSE HA AND PE I-S PROSTHESIS WITH MALLEABLE HEAD

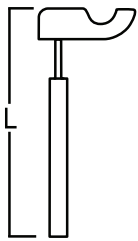

Number	Dimensions
TAP 07.42	Total Length: 8.00 mm Head: 3.50 mm Platinum Wire O.D.: 0.20 Audio-PE O.D.: 0.75

POROUS HA AND PE MALLEABLE I-S WITH MALLEUS SLOT

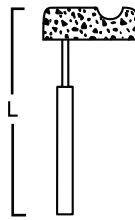

Number	Dimensions
TAP 07.37	Total Length (L): 8.00 to 3.25 mm Head O.D.: 3.50 mm Platinum Wire O.D.: 0.20 mm Audio-PE Columella O.D.: 0.60 mm

POROUS HA AND PTFE MALLEABLE INCUS STAPES WITH MALLEUS SLOT

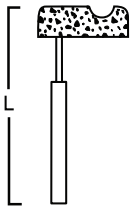

- Platinum wire

Number	Dimensions
TAP 07.35	Total Length (L): 8.00 to 3.25 mm Head O.D.: 3.50 mm Platinum Wire O.D.: 0.20 mm Audio-PE Columella O.D.: 0.60 mm

POROUS AND DENSE HA MALLEABLE I-S

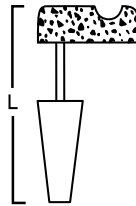

- Platinum wire
- Lower End Columella O.D.: 0.65

Number	Length (mm)
TAP 07.33.550	5.50
TAP 07.33.600	6.00
TAP 07.33.650	6.50
TAP 07.33.700	7.00
TAP 07.33.750	7.50
TAP 07.33.800	8.00

TITANIUM / POROUS HA ADJUSTABLE I-S WITH MALLEUS SLOT

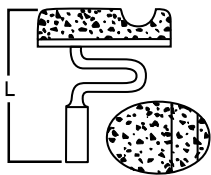

- Extendable stem

Number	Dimensions
TAP 07.67	Total Length (L): 4.00 to 8.00 mm Head size: 3.50 x 2.50 mm

TITANIUM / POROUS HA ADJUSTABLE I-S WITH MALLEUS HOOK

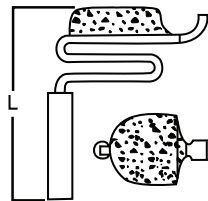

- Extendable stem

Number	Dimensions
TAP 07.58	Total Length (L): 5.00 to 8.50 mm Head size: 3.50 x 2.50 mm Columella O.D.: 0.60 mm

TITANIUM / POROUS HA I-S WITH MALLEUS SLOT

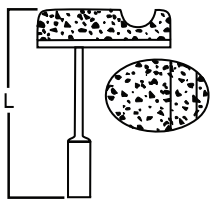

- Columella O.D.: 0.60

Number	L (MM)	Number	L (MM)
TAP 07.65.300	3.00	TAP 07.65.500	5.00
TAP 07.65.325	3.25	TAP 07.65.525	5.25
TAP 07.65.350	3.50	TAP 07.65.550	5.50
TAP 07.65.375	3.75	TAP 07.65.600	6.00
TAP 07.65.400	4.00	TAP 07.65.650	6.50
TAP 07.65.425	4.25	TAP 07.65.700	7.00
TAP 07.65.450	4.50	TAP 07.65.750	7.50
TAP 07.65.475	4.75	TAP 07.65.800	8.00

TITANIUM / PTFE / HAP SPRING TOTAL

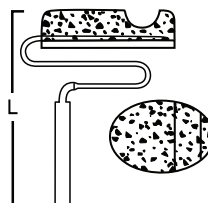

- Wire O.D.: 0.20 mm
- PTFE O.D.: 0.6 mm

Number	Extended L (MM)	Compressed L (MM)
TAP 07.71	8.00 - 4.00	7.30 - 3.30

L = Total Length
FL = Functional Length

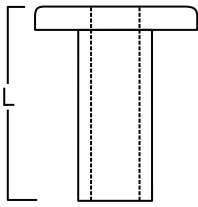
PE PARTIAL

Number	Dimensions
PAP 07.10	Total Length (L): 5.00 mm Columella O.D.: 2.10 mm

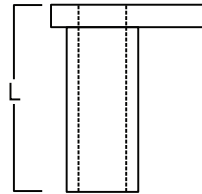
PE OFFSET PARTIAL

Number	Dimensions
TPL 07.02	Total Length (L): 5.00 mm Columella O.D.: 1.80 mm

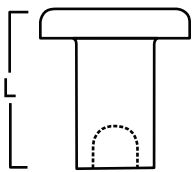
DENSE HA PARTIAL

- Columella O.D.: 2.10

Number	Dimensions
PAP 07.12.300	3.00
PAP 07.12.350	3.50
PAP 07.12.400	4.00
PAP 07.12.450	4.50
PAP 07.12.500	5.00

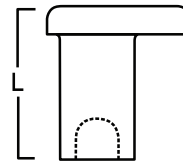
HA OFFSET PARTIAL

- Columella O.D.: 2.00

Number	Dimensions
TPL 07.06.300	3.00
TPL 07.06.350	3.50
TPL 07.06.400	4.00
TPL 07.06.450	4.50
TPL 07.06.500	5.00

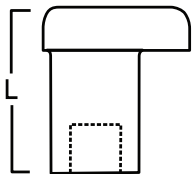
DENSE HA 90° OVAL HEAD PARTIAL

- Columella O.D.: 2.00

Number	Length
PAP 07.15.300	3.00 mm
PAP 07.15.350	3.50 mm
PAP 07.15.400	4.00 mm
PAP 07.15.450	4.50 mm
PAP 07.15.500	5.00 mm

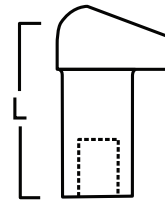
DENSE HA 75° OVAL HEAD PARTIAL

- Columella O.D.: 2.00

Number	Length
PAP 07.16.300	3.00 mm
PAP 07.16.350	3.50 mm
PAP 07.16.400	4.00 mm
PAP 07.16.450	4.50 mm
PAP 07.16.500	5.00 mm

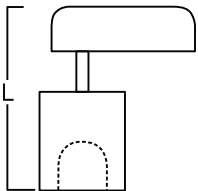
DENSE HA MALLEABLE PARTIAL

- Platinum wire
- Columella O.D.: 2.00

Number	L (MM)	Number	L (MM)
TPL 07.08.350	3.50	TPL 07.08.500	5.00
TPL 07.08.400	4.00	TPL 07.08.550	5.50
TPL 07.08.450	4.50	TPL 07.08.600	6.00

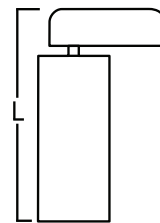
DENSE HA AND PE PARTIAL WITH MALLEABLE HEAD

Number	Dimensions
PAP 07.41	Total Length (L): 6.50 mm Head: 3.50 mm Platinum wire O.D.: 0.25 mm Columella external O.D.: 2.20 mm

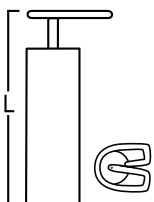
PE PARTIAL WITH MALLEABLE GOLD HEAD

- Trimmable PE columella

Number	Dimensions
PAP 07.47	Total Length (L): 6.50 to 2.75 mm Gold Wire O.D.: 0.30 mm Columella O.D.: 1.80 mm Columella I.D.: 1.20 mm

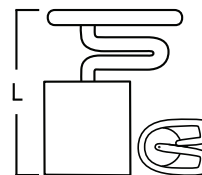
GOLD AND PE PARTIAL WITH MALLEABLE HEAD

- Extendable stem

Number	Dimensions
PAP 07.49	Total Length (L): 2.75 to 6.50 mm Head: 3.00 mm Gold Wire O.D.: 0.30 mm Columella O.D.: 1.80 mm Columella I.D.: 1.20 mm

L = Total Length
FL = Functional Length

DENSE HA TELESCOPIC UNIVERSAL PARTIAL / TOTAL

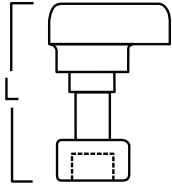

• Columella O.D.: 2.10

Number	Dimensions
PAP 07.19.350	3.50 min / 4.20 max
PAP 07.19.400	4.00 min / 4.70 max
PAP 07.19.450	4.50 min / 5.20 max
PAP 07.19.500	5.00 min / 5.70 max
PAP 07.19.550	5.50 min / 6.20 max
PAP 07.19.600	6.00 min / 6.70 max

TITANIUM PARTIAL

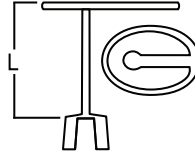

• Columella O.D.: 1.30 / Columella I.D.: 1.10

Number	L (MM)	Number	L (MM)
PAP 07.62.175	1.75	PAP 07.62.325	3.25
PAP 07.62.200	2.00	PAP 07.62.350	3.50
PAP 07.62.225	2.25	PAP 07.62.400	4.00
PAP 07.62.250	2.50	PAP 07.62.450	4.50
PAP 07.62.275	2.75	PAP 07.62.500	5.00
PAP 07.62.300	3.00		

TITANIUM ADJUSTABLE PARTIAL

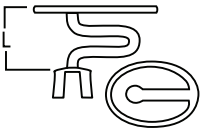

• Extendable Stem

Number	Dimensions
PAP 07.64	Total Length (L): 2.00 to 6.00 mm Head size: 3.50 x 2.50 mm

TITANIUM PARTIAL WITH SLITS IN BELL

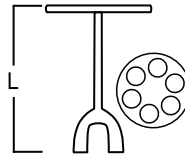

Number	L (MM)	Number	L (MM)
12705	0.50	12720	2.00
12710	1.00	12722	2.25
12712	1.25	12725	2.50
12715	1.50	12730	3.00
12717	1.75	12735	3.50

TITANIUM PARTIAL OFFSET WITH MALLEUS GROOVE

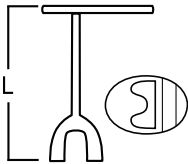

Number	L (MM)	Number	L (MM)
12805	0.50	12820	2.00
12810	1.00	12822	2.25
12812	1.25	12825	2.50
12815	1.50	12830	3.00
12817	1.75	12835	3.50

TITANIUM PARTIAL

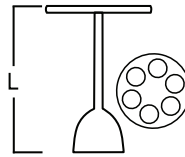

Number	L (MM)	Number	L (MM)
12905	0.50	12920	2.00
12910	1.00	12922	2.25
12912	1.25	12925	2.50
12915	1.50	12830	3.00
12917	1.75	12835	3.50

TITANIUM ADJUSTABLE PARTIAL TRIMMABLE SHAFT

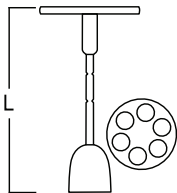

• Trimmable in 1 mm increments

Number	Dimensions
12100	5.50 to 2.50 mm
12200	5.00 to 2.00 mm

L = Total Length
FL = Functional Length

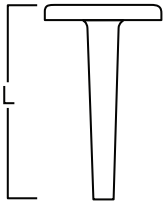
PE TOTAL

• Columella O.D.: 0.70

Number	Length (MM)
TAP 07.09.600	6.00
TAP 07.09.700	7.00
TAP 07.09.800	8.00

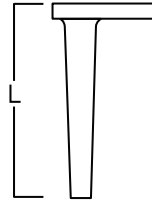
PE OFFSET TOTAL

• Columella O.D.: 0.65

Number	Length (MM)
TPL 07.04.600	6.00
TPL 07.04.700	7.00
TPL 07.04.800	8.00

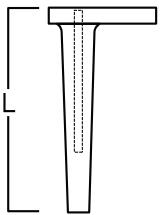
PE MALLEABLE OFFSET TOTAL

• Platinum core

Number	Dimensions
TPL 07.03	Total Length (L): 8.00 mm Columella O.D.: 0.70 mm

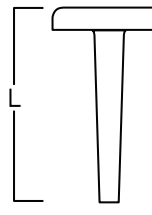
DENSE HA TOTAL

• Columella O.D.: 0.65

Number	L (MM)	Number	L (MM)
TAP 07.11.500	5.00	TAP 07.11.700	7.00
TAP 07.11.550	5.50	TAP 07.11.750	7.50
TAP 07.11.600	6.00	TAP 07.11.800	8.00
TAP 07.11.650	6.50		

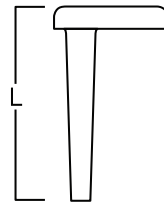
DENSE HA OFFSET TOTAL

• Columella O.D.: 0.70

Number	L (MM)	Number	L (MM)
TPL 07.05.500	5.00	TPL 07.05.700	7.00
TPL 07.05.550	5.50	TPL 07.05.750	7.50
TPL 07.05.600	6.00	TPL 07.05.800	8.00
TPL 07.05.650	6.50		

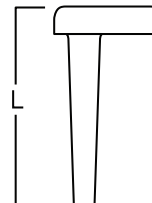
DENSE HA PARTIAL

• Columella O.D.: 0.75

Number	L (MM)	Number	L (MM)
TAP 07.13.500	5.00	TAP 07.13.700	7.00
TAP 07.13.550	5.50	TAP 07.13.750	7.50
TAP 07.13.600	6.00	TAP 07.13.800	8.00
TAP 07.13.650	6.50		

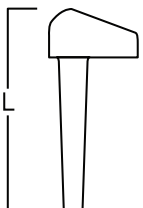
DENSE HA 75° OVAL HEAD TOTAL

• Columella O.D.: 0.70

Number	L (MM)	Number	L (MM)
TAP 07.14.500	5.00	TAP 07.14.700	7.00
TAP 07.14.550	5.50	TAP 07.14.750	7.50
TAP 07.14.600	6.00	TAP 07.14.800	8.00
TAP 07.14.650	6.50		

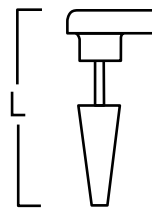
DENSE HA MALLEABLE TOTAL

• Platinum Wire
• Columella O.D.: 0.65

Number	L (MM)	Number	L (MM)
TPL 07.07.550	5.50	TPL 07.07.700	7.00
TPL 07.07.600	6.00	TPL 07.07.750	7.50
TPL 07.07.650	6.50	TPL 07.07.800	8.00

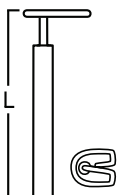
PTFE TOTAL WITH MALLEABLE GOLD HEAD AND SHAFT

• Trimmable PTFE columella

Number	Dimensions
TAP 07.46	Total Length (L): 8.00 to 4.50 mm Head: 3.00 mm Gold wire O.D.: 0.30 mm PTFE O.D.: 0.80 mm

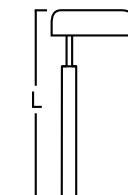
DENSE HA AND PTFE MALLEABLE TOTAL

Number	Dimensions
TAP 07.40	Total Length (L): 8.00 mm Head O.D.: 3.50 mm Platinum Wire O.D.: 0.20 mm Audio-PE Columella O.D.: 0.75 mm

L = Total Length
FL = Functional Length

ADJUSTABLE TOTAL WITH GOLD HEAD AND SHAFT WITH PTFE COLUMELLA

• Extendable stem

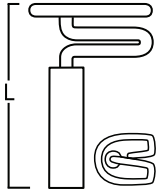

Number	Dimensions
TAP 07.48	Total Length (L): 4.00 to 9.00 mm Head: 3.00 mm Gold Wire O.D.: 0.30 mm PTFE O.D.: 0.80 mm

TITANIUM TOTAL

• Columella O.D.: 0.60

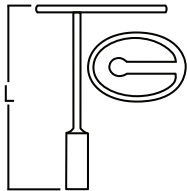

Number	L (MM)	Number	L (MM)
TAP 07.61.300	3.00	TAP 07.61.500	5.00
TAP 07.61.325	3.25	TAP 07.61.525	5.25
TAP 07.61.350	3.50	TAP 07.61.550	5.50
TAP 07.61.375	3.75	TAP 07.61.600	6.00
TAP 07.61.400	4.00	TAP 07.61.650	6.50
TAP 07.61.425	4.25	TAP 07.61.700	7.00
TAP 07.61.450	4.50	TAP 07.61.750	7.50
TAP 07.61.475	4.75	TAP 07.61.800	8.00

TITANIUM ADJUSTABLE TOTAL

• Extendable stem

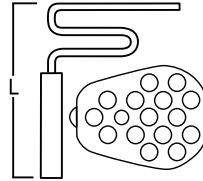

Number	Dimensions
TAP 07.55	Total Length (L): 5.00 to 8.50 mm Head size: 3.80 x 3.00 mm

DENSE HA TELESCOPIC TOTAL TRIMMABLE

• Piston O.D.: 0.80

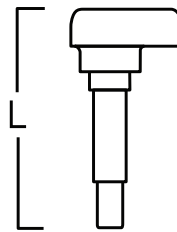

Number	Dimensions (MM)
TAP 07.18.500	5.00 min / 5.70 max
TAP 07.18.550	5.50 min / 6.20 max
TAP 07.18.600	6.00 min / 6.70 max
TAP 07.18.650	6.50 min / 7.20 max
TAP 07.18.700	7.00 min / 7.70 max
TAP 07.18.750	7.50 min / 8.20 max
TAP 07.18.800	8.00 min / 8.70 max

TITANIUM ADJUSTABLE TOTAL AND PARTIAL UNIVERSAL

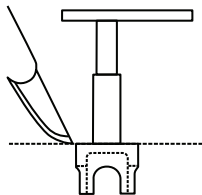

Number	Dimensions
TPL 07.57	Partial: Minimum length: 3.50 mm Columella O.D.: 1.80 mm Columella I.D.: 1.20 mm
	Total: Maximum length: 8.50 mm Columella O.D.: 0.70 mm

TITANIUM ADJUSTABLE TOTAL

• Extendable Stem

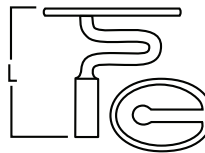

Number	Dimensions
TAP 07.63	Total Length (L): 3.00 to 8.00 mm Head size: 3.50 x 2.50 mm

TITANIUM TRIMMABLE TOTAL WITH SEPARATE HEAD

• Trimmable in 1 mm increments

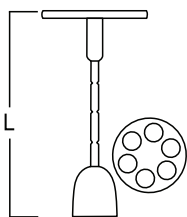

Number	Dimensions
11300	7.5 to 3.50 mm
11400	7.0 to 3.00 mm

TITANIUM TOTAL FIXED LENGTH WITH ADJUSTABLE CENTERED HEAD

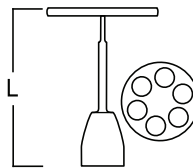

*Fixed head

Number	L (MM)	Number	L (MM)
11930*	3.00	11947	4.75
11935	3.50	11950	5.00
11940	4.00	11960	6.00
11942	4.25	11965	6.50
11945	4.50	11970	7.00

TITANIUM TOTAL TRIMMABLE LENGTH WITH ADJUSTABLE CENTERED HEAD WITH SEPARATE SHOES

• Trimmable PTFE columella

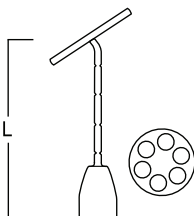

Number	Dimensions
11500	7.50 to 2.80 mm
11600	7.30 to 2.30 mm

TITANIUM MALLEABLE TRIMMABLE TOTAL WITH ADJUSTABLE HEAD AND SEPARATE SHOE

• Trimmable PTFE columella

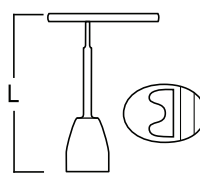

*Fixed head

Number	L (MM)	Number	L (MM)
11830*	3.00	11847	4.75
11835	3.50	11850	5.00
11840	4.00	11860	6.00
11842	4.25	11865	6.50
11845	4.50	11870	7.00

L = Total Length
 FL = Functional Length

DENSE HA POSTERIOR CANAL WALL

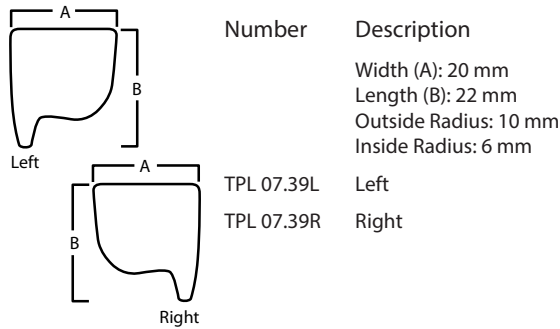

Number	Description
	Width (A): 20 mm
	Length (B): 22 mm
	Outside Radius: 10 mm
	Inside Radius: 6 mm
TPL 07.39L	Left
TPL 07.39R	Right

Caps and Shoe

DENSE HA FOOTPLATE SHOE

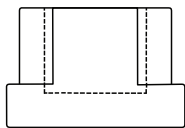

Number	Dimensions
TPL 07.44	Footplate size 2.00 x 1.20 mm
	Inner O.D.: 0.80 mm
	Added implant length: 0.50 mm

DENSE HA PROSTHESIS "MARPLA" BY E. GARCIA IBANEZ

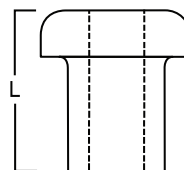

Number	Dimensions
TPL 07.45	Total Length (L): 1 - 3.50 mm
	Total Drilled Head: 4.00 mm
	Inside O.D.: 1.40 mm

POROUS HA CAP



Number	Dimensions
PAP 07.50	Total Length (L): 1.00 - 4.00 mm
	Columella external O.D.: 2.10 mm
	Columella I.D.: 1.20 mm

L = Total Length
FL = Functional Length

PLATINUM AND PTFE PROSTHESES FOR STAPEDECTOMY AND STAPEDOTOMY

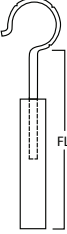

FL / L	Piston O.D.: 0.40 Number	Piston O.D.: 0.50 Number	Piston O.D.: 0.60 Number	Piston O.D.: 0.80 Number
3.00 / 4.00	SPL 03.08.400	SPL 03.09.400	SPL 03.07.400	SPL 03.10.400
3.25 / 4.25	SPL 03.08.425	SPL 03.09.425	SPL 03.07.425	SPL 03.10.425
3.50 / 4.50	SPL 03.08.450	SPL 03.09.450	SPL 03.07.450	SPL 03.10.450
3.75 / 4.75	SPL 03.08.475	SPL 03.09.475	SPL 03.07.475	SPL 03.10.475
4.00 / 5.00	SPL 03.08.500	SPL 03.09.500	SPL 03.07.500	SPL 03.10.500
4.25 / 5.25	SPL 03.08.525	SPL 03.09.525	SPL 03.07.525	SPL 03.10.525
4.50 / 5.50	SPL 03.08.550	SPL 03.09.550	SPL 03.07.550	SPL 03.10.550
4.75 / 5.75	SPL 03.08.575	SPL 03.09.575	SPL 03.07.575	SPL 03.10.575
5.00 / 6.00	SPL 03.08.600	SPL 03.09.600	SPL 03.07.600	SPL 03.10.600
5.25 / 6.25	SPL 03.08.625	SPL 03.09.625	SPL 03.07.625	SPL 03.10.625
5.50 / 6.50	SPL 03.08.650	SPL 03.09.650	SPL 03.07.650	SPL 03.10.650
8.99 / 9.99	SPL 03.08.999	SPL 03.09.999	SPL 03.07.999	SPL 03.10.999

TITANIUM PROSTHESES FOR STAPEDECTOMY AND STAPEDOTOMY

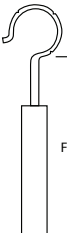

FL / L	Piston O.D.: 0.40 Number	Piston O.D.: 0.50 Number	Piston O.D.: 0.60 Number	Piston O.D.: 0.80 Number
3.00 / 4.00	SPL 03.21.400	SPL 03.22.400	SPL 03.20.400	SPL 03.23.400
3.25 / 4.25	SPL 03.21.425	SPL 03.22.425	SPL 03.20.425	SPL 03.23.425
3.50 / 4.50	SPL 03.21.450	SPL 03.22.450	SPL 03.20.450	SPL 03.23.450
3.75 / 4.75	SPL 03.21.475	SPL 03.22.475	SPL 03.20.475	SPL 03.23.475
4.00 / 5.00	SPL 03.21.500	SPL 03.22.500	SPL 03.20.500	SPL 03.23.500
4.25 / 5.25	SPL 03.21.525	SPL 03.22.525	SPL 03.20.525	SPL 03.23.525
4.50 / 5.50	SPL 03.21.550	SPL 03.22.550	SPL 03.20.550	SPL 03.23.550
4.75 / 5.75	SPL 03.21.575	SPL 03.22.575	SPL 03.20.575	SPL 03.23.575
5.00 / 6.00	SPL 03.21.600	SPL 03.22.600	SPL 03.20.600	SPL 03.23.600
5.25 / 6.25	SPL 03.21.625	SPL 03.22.625	SPL 03.20.625	SPL 03.23.625
5.50 / 6.50	SPL 03.21.650	SPL 03.22.650	SPL 03.20.650	SPL 03.23.650
8.99 / 9.99	SPL 03.21.999	SPL 03.22.999	SPL 03.20.999	SPL 03.23.999

TRIMMABLE PLATINUM AND PTFE PROSTHESES FOR STAPEDECTOMY AND STAPEDOTOMY

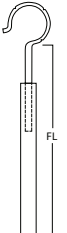

FL / L	Piston O.D.: 0.40 Number	Piston O.D.: 0.50 Number	Piston O.D.: 0.60 Number	Piston O.D.: 0.80 Number
6.0 - 3.25 / 7.00 - 4.25	SPL 03.08S	SPL 03.09S	SPL 03.07S	SPL 03.10S

TRIMMABLE TITANIUM AND PTFE FOR STAPEDECTOMY AND STAPEDOTOMY

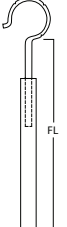

FL / L	Piston O.D.: 0.40 Number	Piston O.D.: 0.50 Number	Piston O.D.: 0.60 Number	Piston O.D.: 0.80 Number
6.0 - 3.25 / 7.00 - 4.25	SPL 03.27S	SPL 03.28S	SPL 03.29S	SPL 03.30S

L = Total Length
FL = Functional Length

PTFE LOOP PROSTHESIS WITH NOTCH FOR STAPEDECTOMY AND STAPEDOTOMY - TRIMMABLE

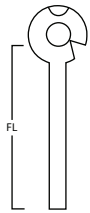

Number	FL (MM)	L (MM)	Piston Ø
SPL 03.16	3.00-6.00	4.00-7.00	0.50
SPL 03.17	3.00-6.00	4.00-7.00	0.60
SPL 03.18	3.00-6.00	4.00-7.00	0.40
SPL 03.19	3.00-6.00	4.00-7.00	0.80

PTFE LOOP PROSTHESIS WITHOUT NOTCH FOR STAPEDECTOMY AND STAPEDOTOMY - TRIMMABLE

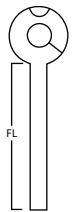

Number	FL (MM)	L (MM)	Piston Ø
SPL 03.16x	3.00-6.00	4.00-7.00	0.50
SPL 03.17x	3.00-6.00	4.00-7.00	0.60
SPL 03.18x	3.00-6.00	4.00-7.00	0.40
SPL 03.19x	3.00-6.00	4.00-7.00	0.80

SULTAN LOOP PISTON PROSTHESIS FOR STAPEDECTOMY AND STAPEDOTOMY

- Silicon loop
- TI joint
- PTFE columella

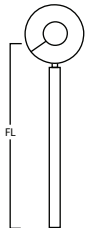

Number	FL (MM)	L (MM)	Piston Ø
SPL 03.24	3.00-6.00	4.00-7.00	0.40
SPL 03.25	3.00-6.00	4.00-7.00	0.50
SPL 03.26	3.00-6.00	4.00-7.00	0.60

PLATINUM AND PE PROSTHESIS FOR STAPEDECTOMY

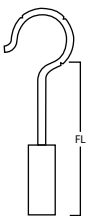

Number	FL (MM)	L (MM)
SPL 03.04.300	2.00	3.00
SPL 03.04.350	2.50	3.50
SPL 03.04.400	3.00	4.00
SPL 03.04.425	3.25	4.25
SPL 03.04.450	3.50	4.50
SPL 03.04.475	3.75	4.75
SPL 03.04.500	4.00	5.00
SPL 03.04.550	4.50	5.50
SPL 03.04.600	5.00	6.00

TRIMMABLE TITANIUM / PTFE SELF CRIMPING PROSTHESIS

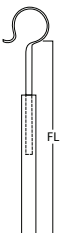

Number	FL (MM)	L (MM)	Piston Ø
SPL 03.35S	6.00-3.25	7.00-4.25	0.40
SPL 03.36S	6.00-3.25	7.00-4.25	0.50
SPL 03.37S	6.00-3.25	7.00-4.25	0.60
SPL 03.38S	6.00-3.25	7.00-4.25	0.80

PLATINUM PROSTHESIS FOR STAPEDECTOMY

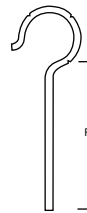

Number	FL (MM)	L (MM)	Piston Ø
SPL 03.05	5.00	6.0	0.30

PTFE LOOP PROSTHESIS WITHOUT NOTCH FOR STAPEDECTOMY AND STAPEDOTOMY - FIXED

- Sterile
- Expand Loop with pick and slip over incus

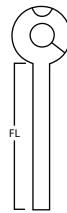

Number	FL (MM)	L (MM)	Piston Ø
24-0450	4.00	5.00	0.40
24-0640	3.00	4.00	0.60
24-0645	3.50	4.50	0.60
24-0650	4.00	5.00	0.60
24-0660	5.00	6.00	0.60

HOUSE TYPE PLATINUM LOOPED FOR STAPEDECTOMY PROSTHESIS

- Platinum loop O.D.: 0.40

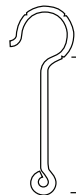

Number	FL (MM)	L (MM)
SPL 03.15.400	3.00	4.00
SPL 03.15.450	3.50	4.50
SPL 03.15.500	4.00	5.00

PLATINUM RIBBON LOOP AND SHAFT FOR STAPEDECTOMY PROSTHESIS



Number	FL (MM)	L (MM)
SPL 03.00.300	2.00	3.00
SPL 03.00.350	2.50	3.50
SPL 03.00.400	3.00	4.00
SPL 03.00.425	3.25	4.25
SPL 03.00.450	3.50	4.50
SPL 03.00.475	3.75	4.75
SPL 03.00.500	4.00	5.00
SPL 03.00.550	4.50	5.50
SPL 03.00.600	5.00	6.00

HOUSE TYPE PLATINUM LOOPED STAPEDECTOMY PROSTHESIS WITH BALL BASE

- Platinum sphere O.D.: 0.40

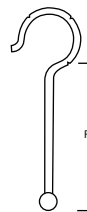

Number	FL (MM)	L (MM)
SPL 03.13.400	3.00	4.00
SPL 03.13.450	3.50	4.50
SPL 03.13.500	4.00	5.00

L = Total Length
FL = Functional Length

TITANIUM BUCKET HANDLE

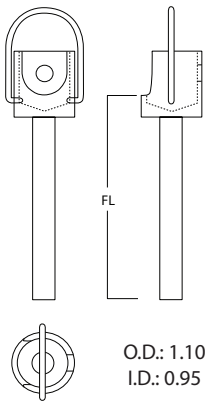

FL / L	Piston O.D.: 0.40 Number	Piston O.D.: 0.50 Number	Piston O.D.: 0.60 Number	Piston O.D.: 0.80 Number
3.20 / 4.00	SPL 03.48.400	SPL 03.51.400	SPL 03.49.400	SPL 03.50.400
3.45 / 4.25	SPL 03.48.425	SPL 03.51.425	SPL 03.49.425	SPL 03.50.425
3.70 / 4.50	SPL 03.48.450	SPL 03.51.450	SPL 03.49.450	SPL 03.50.450
3.95 / 4.75	SLP 03.48.475	SPL 03.51.475	SLP 03.49.475	SLP 03.50.475
4.20 / 5.00	SPL 03.48.500	SPL 03.51.500	SPL 03.49.500	SPL 03.50.500
4.45 / 5.25	SPL 03.48.525	SPL 03.51.525	SPL 03.49.525	SPL 03.50.525
4.70 / 5.50	SPL 03.48.550	SPL 03.51.550	SPL 03.49.550	SPL 03.50.550
4.95 / 5.75	SPL 03.48.575	SPL 03.51.575	SPL 03.49.575	SPL 03.50.575
5.20 / 6.00	SPL 03.48.600	SPL 03.51.600	SPL 03.49.600	SPL 03.50.600
5.45 / 6.25	SPL 03.48.625	SPL 03.51.625	SPL 03.49.625	SPL 03.50.625
5.70 / 6.50	SPL 03.48.650	SPL 03.51.650	SPL 03.49.650	SPL 03.50.650
5.95 / 6.75	SPL 03.48.675	SPL 03.51.675	SPL 03.49.675	SPL 03.50.675
6.20 / 7.00	SPL 03.48.700	SPL 03.51.700	SPL 03.49.700	SPL 03.50.700
6.45 / 7.25	SPL 03.48.725	SPL 03.51.725	SPL 03.49.725	SPL 03.50.725
6.70 / 7.50	SPL 03.48.750	SPL 03.51.750	SPL 03.49.750	SPL 03.50.750

PTFE/AUDIOLITE ADJUSTABLE CUP PROSTHESIS FOR STAPEDECTOMY

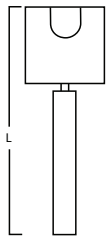

- Porous HA
- AUDIOLITE - cup
- PT - joint
- PTFE - columella

Number	Dimensions
SPL 03.14	L: 6.00 mm Cup O.D.: 2.00 mm Cup I.D.: 1.20 mm Columella O.D.: 0.60 mm

L = Total Length
FL = Functional Length

SELF-CRIMPING SUPERELASTIC NITINOL/PTFE PISTON

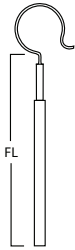

		Columella O.D.: 0.40	Columella O.D.: 0.50	Columella O.D.: 0.60	Columella O.D.: 0.80
FL / L	Number	Number	Number	Number	Number
3.00 / 4.00	SPL 03.43.400	SPL 03.44.400	SPL 03.45.400	SPL 03.46.400	
3.25 / 4.25	SPL 03.43.425	SPL 03.44.425	SPL 03.45.425	SPL 03.46.425	
3.50 / 4.50	SPL 03.43.450	SPL 03.44.450	SPL 03.45.450	SPL 03.46.450	
3.75 / 4.75	SPL 03.43.475	SPL 03.44.475	SPL 03.45.475	SPL 03.46.475	
4.00 / 5.00	SPL 03.43.500	SPL 03.44.500	SPL 03.45.500	SPL 03.46.500	
4.25 / 5.25	SPL 03.43.525	SPL 03.44.525	SPL 03.45.525	SPL 03.46.525	
4.50 / 5.50	SPL 03.43.550	SPL 03.44.550	SPL 03.45.550	SPL 03.46.550	
4.75 / 5.75	SPL 03.43.575	SPL 03.44.575	SPL 03.45.575	SPL 03.46.575	
5.00 / 6.00	SPL 03.43.600	SPL 03.44.600	SPL 03.45.600	SPL 03.46.600	
5.50 / 6.50	SPL 03.43.650	SPL 03.44.650	SPL 03.45.650	SPL 03.46.650	
6.00 / 7.00	SPL 03.43.700	SPL 03.44.700	SPL 03.45.700	SPL 03.46.700	
6.50 / 7.50	SPL 03.43.750	SPL 03.44.750	SPL 03.45.750	SPL 03.46.750	
7.00 / 8.00	SPL 03.43.800	SPL 03.44.800	SPL 03.45.800	SPL 03.46.800	
7.50 / 8.50	SPL 03.43.850	SPL 03.44.850	SPL 03.45.850	SPL 03.46.850	
8.00 / 9.00	SPL 03.43.900	SPL 03.44.900	SPL 03.45.900	SPL 03.46.900	
8.50 / 9.50	SPL 03.43.950	SPL 03.44.950	SPL 03.45.950	SPL 03.46.950	
8.99 / 9.99	SPL 03.43.999	SPL 03.44.999	SPL 03.45.999	SPL 03.46.999	

SELF-CRIMPING TRIMMABLE SUPERELASTIC NITINOL PISTON

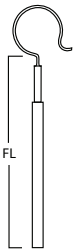

		Columella O.D.: 0.40	Columella O.D.: 0.50	Columella O.D.: 0.60	Columella O.D.: 0.80
FL / L	Number	Number	Number	Number	Number
6.0-6.25 / 7.00-4.25	SPL 03.43S	SPL 03.44S	SPL 03.45S	SPL 03.46S	

E-GATOR ALLIGATOR FORCEPS

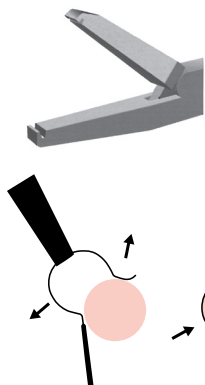

Number	Description
SPL 03.01	E-Gator, alligator forceps, 4.0x0.9mm jaws, w/micro-slots. Stainless steel, length: 70cm, 2 3/4".



L = Total Length
 FL = Functional Length

BASIC BLOCK FOR THE TOTAL AND PARTIAL IMPLANT SHORTENING SCALES



Number	Dimensions
PF001-10	Shortening Block

SHORTENING SCALES FOR USE WITH THE BASIC BLOCK FOR TOTAL IMPLANTS WITH FIXED HEAD



Number	Dimensions
PF001-11	Tower for Fixed Head (Total)

SHORTENING SCALES FOR USE WITH THE BASIC BLOCK FOR PARTIAL IMPLANTS



Number	Dimensions
PF001-12	Tower for Partial

SHORTENING SCALES FOR USE WITH THE BASIC BLOCK FOR TOTAL IMPLANTS WITH FIXED SHOE



Number	Dimensions
PF001-13	Tower for Fixed Shoe (Total)

MEASURING GAUGE



Number	Dimensions
02.14	Measuring Instrument

HILDMANN CARTILAGE HOLDING AND CUTTING FORCEPS



Number	Dimensions
O10-504-10	Straight, 10 CM, Stainless with set screw

L = Total Length
 FL = Functional Length

TRIALS FOR TITANIUM TOTAL IMPLANTS

• Stainless steel

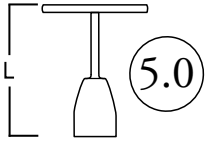

Number	L (MM)	Number	L (MM)
11000-D20	2.0	11000-D50	5.0
11000-D25	2.5	11000-D55	5.5
11000-D30	3.0	11000-D60	6.0
11000-D35	3.5	11000-D65	6.5
11000-D40	4.0	11000-D70	7.0
11000-D45	4.5	11000-D75	7.5

TRIALS FOR TITANIUM PARTIAL IMPLANTS

• Stainless steel

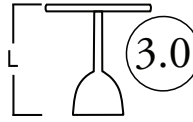

Number	L (MM)	Number	L (MM)
12000-D05	0.5	12000-D30	3.0
12000-D10	1.0	12000-D35	3.5
12000-D15	1.5	12000-D40	4.0
12000-D17	1.75	12000-D45	4.5
12000-D20	2.0	12000-D50	5.0
12000-D25	2.5	12000-D55	5.5

*** NOT FOR IMPLANTATION • REUSABLE ***

GELFOAM PRESS

- Stainless, 18 cm



Number	Dimensions
O64500	Platform 11x14 mm
O64501	Platform 30x30 mm
O64502	Platform 22x30 mm

HOUSE STYLE CUTTING BLOCK

- 2.87" x 1.5" x 9.0 mm
- Non-Sterile

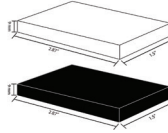

Number	Dimensions
O99131	White Delrin
O99131B	Black Delrin

PHENOL APPLICATOR

- Duberstein Type

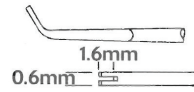

Number	Dimensions
O99610	Round handle, Stainless, Matt, Length 15.7 cm Tynes : 0.63 mm x 1.57 mm

LARYNGEAL ACCESSORIES

R&CS ACC

DIS

OTO ACC

OSS

LAR ACC

SPE ACC

RHI INS

PSB

OTO INS

LAR INS

ORO/NAS INS



The Clearview™ II improved design simplifies aseptic mounting, securing and removing the sheath without worry of scope damage.

- Proven Effective Barrier to Microorganisms as Small as 25nm*
- Patent Pending Securement
- Easy On, Easy Off- No Slip!
- Superb Optical Quality
- Universal Fit
- 100% Latex Free
- Sterile, Individually Packaged

Number	Description		Qty/ Box
28-36000	Flexible Endoscope Cover Fits 3.6mm Flexible Endoscopes	Adult	20

Tracheal T-Tube

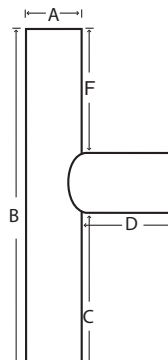
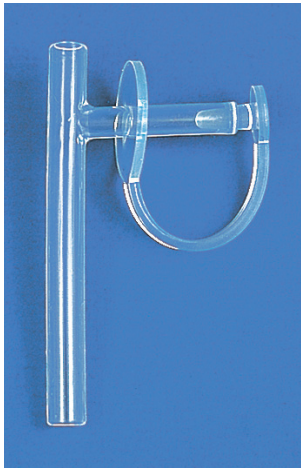

Designed for the surgical management of tracheal and subglottic stenosis and the reconstruction of cervical and thoracic trachea. Packaged 1 each.

- 100% medical grade silicone
- Easily trimmed to meet patient's needs
- Large soft collar with closure attached

Number	Size	A	B	C	D	E	F
70-50080	Standard	8 mm	37 mm	16.5 mm	32 mm	6.5 mm	14 mm
70-50100	Standard	10 mm	50 mm	24 mm	42 mm	8 mm	18 mm
70-50120	Standard	12 mm	66 mm	32 mm	50 mm	10.5 mm	23 mm
70-50140	Standard	14 mm	71 mm	34 mm	50 mm	10.5 mm	26 mm
70-50160	Standard	16 mm	72 mm	34 mm	60 mm	11.5 mm	26 mm
70-50081	Long	8 mm	80 mm	60 mm	32 mm	6.5 mm	14 mm
70-50101	Long	10 mm	96 mm	70 mm	42 mm	8 mm	18 mm
70-50121	Long	12 mm	108 mm	75 mm	50 mm	10.5 mm	23 mm
70-50141	Long	14 mm	112 mm	75 mm	50 mm	10.5 mm	26 mm
70-50161	Long	16 mm	122 mm	85 mm	60 mm	11.5 mm	26 mm

Disposable Adenoid Curettes

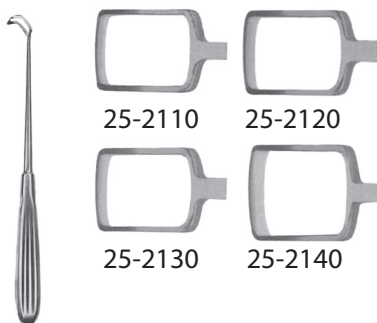

BECKMANN ADENOID CURETTE

- Sterile
- Single-use
- Sharp cutting edge for each case

Number	Description		Length	Size	Head Width	Qty/ Box
25-2110	Adenoid Curette	Straight	22 cm	1	10 mm	5
25-2120	Adenoid Curette	Straight	22 cm	2	12 mm	5
25-2130	Adenoid Curette	Straight	22 cm	3	14 mm	5
25-2140	Adenoid Curette	Straight	22 cm	4	16 mm	5

Surface Electrodes

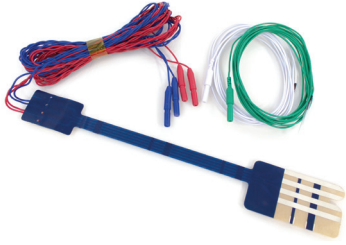

Thyroidectomy 2-Channel Kit

Catalog No.	Description	Quantity
29-80500DCK	One (1) each 29-80500DC - Dual Channel Laryngeal Electrode One (1) each NE-S-250013/0.4 - White needle electrode One (1) each 29-80250 - Green return needle electrode	5 Kits / Box



Facial Nerve Procedure Kit

Catalog No.	Description	Quantity
29-80600K	One (1) each Paired Twisted Subdermal Needle Electrode Red/Red One (1) each Paired Twisted Subdermal Needle Electrode Blue/Blue One (1) each White Needle Electrode One (1) each Green Return Needle Electrode	1 Kits / Box



Probes

Catalog No.	Description	Quantity
PNT 0.8/90	Flush Tip Monopolar Stimulator Probe	10/ Box
29-3001	Direct Tip Monopolar Stimulator Probe	10/ Box

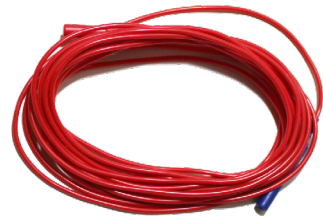

Stim Wire

Catalog No.	Description	Quantity
EW3000/1.8	Red Stim Wire	5/ Box

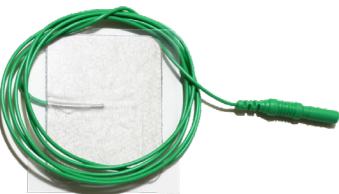

Single Electrodes

Catalog No.	Description	Quantity
SEAg-S-10000/20	Green Hydrogel Surface Electrode	5/ Box



Disposable Subdermal Needle Electrodes

Catalog No.	Description	Size	Quantity
NE-S-2500/13/0.4	White Single Subdermal Needle Electrode	13 x 0.40mm (0.5" x 27G)	5 / Box
29-80250	Green Single Ground Needle Electrode	27 Gauge	5 / Box
NE-T-1500/13/0.4R	Red/Red Single Twisted Subdermal Needle Electrode	13 x 0.40mm (0.5" x 27G)	5 / Box
NE-T-1500/13/0.4B	Blue/Blue Single Twisted Subdermal Needle Electrode	13 x 0.40mm (0.5" x 27G)	5 / Box

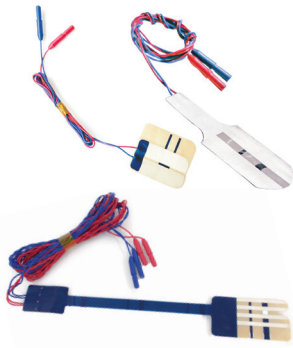

Surface Electrodes
• Single Use Sterile

Catalog No.	Description		ET Tube	Quantity
29-80500S	Single channel surface electrode	Standard	7.5-10mm	5/Box
29-80500W	Single channel surface electrode	Wrap around	7.5-10mm	5/Box
29-80500DC	Dual channel electrode	Standard	6.0-7.5mm	5/Box

Needle Electrodes



Catalog No.	Description	ET Tube	Quantity
29-80250	Single ground needle, green	27G 25mm	5/Box

Lead Wires



Catalog No.	Description	ET Tube	Quantity
29-80250-B	Twisted lead wires with paired needle tips, blue/white	27G 25mm	5/Box
29-80250-G	Twisted lead wires with paired needle tips, green/white	27G 25mm	5/Box
29-80250-O	Twisted lead wires with paired needle tips, orange/white	27G 25mm	5/Box
29-80250-R	Twisted lead wires with paired needle tips, red/white	27G 25mm	5/Box
29-80250-Y	Twisted lead wires with paired needle tips, yellow/white	27G 25mm	5/Box

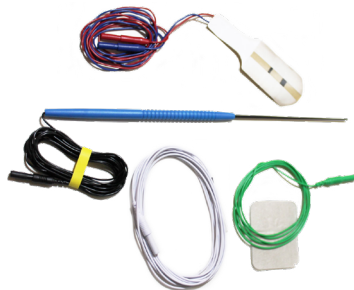

Thyroidectomy Laryngeal Kit

Catalog No.	Description	Quantity
29-80500K	One (1) each 29-80500 S-Standard Single Channel Electrode One (1) each PNT 0.8/90 - Flush Tip Monopolar Stimulator Probe One (1) each SEAg-S-10000/20 - Green Hydrogel Surface Electrode One (1) each NE-S-250013/0.4 - White Needle Electrode	5 Kits / Box

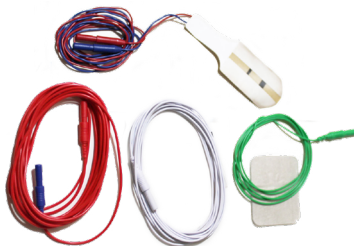

Stim Kit

Catalog No.	Description	Quantity
29-80500SK	One (1) each 29-80500 S-Standard Single Channel Electrode One (1) each NE-S-250013/0.4 - White needle electrode One (1) each - Red Disposable Stim Wire One (1) each SEAg-S-10000/20 - Green Hydrogel Surface Electrode	5 Kits / Box

Monopolar Forceps



Catalog No.	Description
29-80700	Adson Tonsil monopolar Forceps, Fine Curved, Serrated Tips, 7.25"
29-80800	Mosquito Monopolar Forceps, 5", Fine Curved Tip, Box Hing

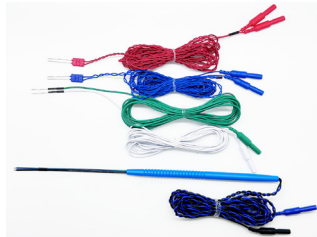

Intraoperative Hypoglossal Nerve Monitoring Kit

Catalog No.	Description	Size	Quantity
29-80700K	One (1) each Twisted NE-D1-2500/18/.04R: Red	18mm X 0.40mm X 2.5M	5 Kits/Box
	One (1) each Twisted NE-D1-2500/18/.04B: Blue	18mm X 0.40mm X 2.5M	
	One (1) each Disposable NE-S-2500/13/.04G: Green		
	Subdermal Needle Electrode		
	One (1) each NE-S-2500/13/.04W: White		
	Subdermal Needle Electrode		
	One (1) each PNB 0.8 X 2/90 Bipolar Stimulator Probe		
Sterile - Single Use			



SPECIALTY PRODUCTS

R&CS ACC

DIS

OTO ACC

OSS

LAR ACC

SPE ACC

RHI INS

PSB

OTO INS

LAR INS

ORO/NAS INS



BRIGHTSTAR™ HIGH POWER WIRELESS LED HEADLIGHT SYSTEM

- Focusable, battery powered, bright, white LED
- Ultra comfortable, adjustable black head band
- Dual long lasting, rechargeable lithium ion batteries (7 hours continuous)

Light Spot Distance	Spot Ø
20-30 cm	38-55 mm
40 cm	53-85 mm
50 cm	68-110 mm
60 cm	80-135 mm

Number	Description
34-4800	BrightStar™ High Power wireless LED Headlight System Includes: Wireless LED headlight with removable dual battery packs, charging station, black headband
34-4701	Lithium Ion battery pack replacement for 34-4800
34-4803	Dual Charging Station replacement



BRIGHTSTAR™ HIGH POWER LED HEADLIGHT

- Focusable, battery powered, bright, white LED
- Light emitting diode technology (LED), life > 30,000 hours
- Ultra-light and comfortable, adjustable crowned headlight with replaceable liners
- Long lasting, rechargeable lithium ion battery (4 hours continuous)

Light Spot Distance	Spot Ø
20-30 cm	38-55 mm
40 cm	53-85 mm
50 cm	68-110 mm
60 cm	80-135 mm

Number	Description
34-4810	High Powered Headlight with belt mounted battery pack
34-4811	Belt worn lithium ion battery for headlight
34-4812	110V transformer/charger for battery pack



BRIGHTSTAR™ ULTRA WIRELESS LED HEADLIGHT SYSTEM

- Focusable, battery powered, bright, white LED
- Ultra comfortable, adjustable black head band
- Long lasting, rechargeable lithium ion battery (3-5 hours continuous)

Light Spot Distance	Spot Ø
20 cm	11-40 mm
30 cm	13-63 mm
40 cm	25-130 mm

Number	Description
34-4700	BrightStar™ Ultra wireless LED Headlight System Includes: Wireless LED headlight, removable battery pack, charger 110-220v, black headband
34-4701	Lithium Ion battery pack replacement for 34-4700
34-4702	Charger 110/220 VAC replacement for 34-4700
34-4703	Charging Station



BRIGHTSTAR™ II LED HEADLIGHT SYSTEM

- Focusable, battery powered, bright, white LED
- Ultra comfortable, adjustable black head band
- Dual long lasting, rechargeable lithium ion batteries (5 hours continuous)

Light Spot Distance	Spot Ø
20 cm	11-40 mm
30 cm	13-63 mm
40 cm	25-130 mm

Number	Description
34-4190	BrightStar™ II LED headlight, lithium ion battery, charger 110-220v, black headband
34-4191	Lithium Ion battery pack replacement with belt clip
34-4192	Charger for 34-4190



IFO FIBEROPTIC HEADLIGHT WITH OPEN HEADBAND

- Adjustable lightweight headband, F/O headlight, bifurcated clear cable illumination for long term balance, comfort and wear
- High performance optical system
- Wide focus range and powerful light spot

Light Spot Distance	Spot Ø
20 cm	11-68 mm
30 cm	12-101 mm
40 cm	13-136 mm
50 cm	14-173 mm
60 cm	16-208 mm

Number	Description
34-4160	IFO Focusable Fiberoptic Headlight, open headband, bifurcated cable illumination, black headband



IFO FIBEROPTIC HEADLIGHT WITH CRADLE HEADBAND

- Super adjustable lightweight headband , F/O headlight, bifurcated clear cable illumination for long term balance, stability, comfort and wear
- High performance optical system
- Wide focus range and powerful light spot

Light Spot Distance	Spot Ø
20 cm	11-68 mm
30 cm	12-101 mm
40 cm	13-136 mm
50 cm	14-173 mm
60 cm	16-208 mm

Number	Description
34-4360	IFO Focusable Fiberoptic Headlight, cradle headband, bifurcated cable illumination, black headband



FIBEROPTIC HEADLIGHT

- Ultra lightweight
- Adjustable for comfortable fit
- Can be used with most standard cables, 3 mm, 9 ft cable available
- Cables available to fit light sources of: K. Storz, Pilling, Olympus, Wolf ACMI

Number	Description
34-4060	Fiber Optic Headlight (cable not included)
34-4061	Fiber Optic Headlight, Micro Spot (cable not included)
34-4065	Fiber Optic Cable, ACMI fittings, 3.0 mm, 9' long



FIBEROPTIC HEADLIGHT

- 90° focusable headlight
- Headlight module, 10-100mm variable spot
- Detachable joysticks (2)
- Set of cushioned detachable sweatbands
- Bifurcated cable, 9" with Wolf lens proximal as standard

Number	Description
GMF-H100	Surgical headlight with cradle



DIGITAL LED 4000 LIGHTING SYSTEM

- Lamp Light emitting diode technology (LED), life > 30,000 hours
- Color temperature 6500° K @ 75 CRI or 5600°K @ 92 CRI
- Intensity control Electronic (PWM) from 0 to 100%
- Turret, 4 ports ACMI, Olympus, Storz, Wolf (others available)
- Power 100-240V AC, 50/*60 Hz, worldwide operation
- Dimensions (WxHxD) 11"W x 4.5" H x 11" D; weight 3.4kg
- Weight 7.5 lbs (3.4kg)
- Regulatory IEC60601-1 3rd Edition, CAN/CSA C22.2 No. 601.1, **CE** mark

Number	Description
34-5000	Swivel mount floor stand and swivel mount floor stand adapter mounting plate kit
34-4900	Deluxe Headlight with 20-110mm variable spot module and 4mm bifurcated headlight cable (black) with Wolf L/S end tip
34-4950	Digital LED lightsource with ergonomic 4-port turret, PWM dimming control, cable end-tip sensor, standby mode, RS32 & USB port for remote control.



LED LIGHTSOURCE

- Lamp Light emitting diode technology (LED), life > 50,000 hours
- Color temperature 6500° K Normal
- Intensity control Electronic (PWM) from 0 to 100%
- Turret, 4 ports ACMI, Olympus, Storz, Wolf (others available)
- Non-Turret model Available upon request
- Power 52W typical; 10-240V AC, 50/*60 Hz, worldwide operation
- Dimensions (WxHxD) 4.65" x 3.32" x 7.25" mm (~10" overall)
- Weight 2.5lbs (1.14kg), EN60601-1-2
- Regulatory UL60601-1, CAN/CSA C22.2 No. 601.1, **CE** mark

Number	Description
LLS-2000T	Premium light source, 4 -turret, generating 50% greater output than LLS1000T



UNIVERSAL HALOGEN LIGHTSOURCE HL 150

- Compact, lightweight halogen lightsource for universal use
- Lamp 1 Halogen reflector lamp, 150 Watt, 15 V
- Color temperature 3.600oK
- Intensity control stepless/mechanical diaphragm adapter exchangeable
- Light guide adapter exchangeable
- Power supply 110/115 VAC or 230/240 VAC, switchable
- Dimensions (WxHxD) 6.8" x 3" x 8", 175 x 82,5 x 202 mm
- Weight 3,5 kg
- Power consumption max. 160 Watt
- Manufactured/tested acc. IEC 601-1 / EN 60601-1, 93/42 ECC

Number	Description
34-3135	Halogen Light Box 150 watt ACMI connector (pictured)

HALOGEN LIGHT CABLE ADAPTERS

Female connectors for F/O Cables & Flexible scope Light Cable Connectors

Number	Description
34-0754	Light box adapter for ACMI
34-0742	Light box adapter for Olympus
34-0752	Light box adapter for Storz
34-0753	Light box adapter for Wolf
34-0755	Light box adapter for Machita

Stands and Light Box Trolleys – Available upon request



CABLES

Number	Description
--------	-------------

34-3140	Fiber Optic Cable, ACMI fittings, 4.0mm 8' long
---------	---

34-4065	Fiber Optic Cable, ACMI fittings, 3.0 mm, 9' long
---------	---

- Other fittings available (ex. Karl Storz Pilling, Olympus, Wolf)
- Custom size cables available upon request



HEAD MIRROR

- Unbreakable exam mirror - Guaranteed!
- Comfortable leather headband with velcro adjustability
- Removable/washable headband liner
- Mirror is approximately 2.9 inches in diameter
- View-hole is 0.5 inches in diameter

Number	Description
--------	-------------

34-4010	Unbreakable Head Mirror w/headband
---------	------------------------------------

34-4011	Unbreakable Head Mirror only
---------	------------------------------

34-4012	Headband only
---------	---------------

34-4075	Replacement liners for head band
---------	----------------------------------



POCKET LIGHT

- Small convenient size - very lightweight
- Bright white Xenon bulb
- Otoscopic adapter for standard disposable specula
- Nasal/Oral exam head

Number	Description
--------	-------------

34-4000	ENT Pocket Light w/Case
---------	-------------------------

BRIGHTSTAR™ PORTABLE LIGHT SOURCE

- Bright, white, portable, efficient light source for Rod Lens Oscopes, Sinus Scopes, Indirect Vision Rod Lens Laryngoscopes, Flexible Nasopharyngoscopes
- Uses the same belt clipped battery pack as the headlight
- Portable LED, Battery powered light source

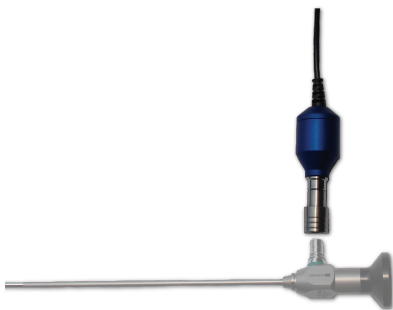

Number	Description
--------	-------------

34-4020	BrightStar™ LED complete Light Source System
---------	--

34-4021	ACMI scope adapter
---------	--------------------

34-4022	Richard Wolf Scope adapter
---------	----------------------------

34-4023	Karl Storz, Gyrus, Olympus scope adaptor
---------	--

34-4092	Charger and wall connector
---------	----------------------------

SPE ACC

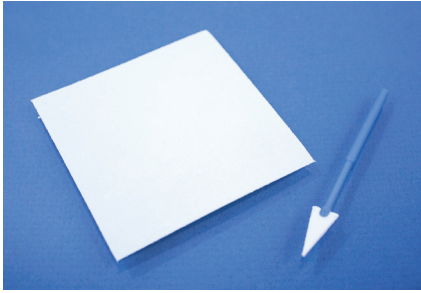

Invotec Number	Merocel [®] Number	Description		Qty/Box
22-70101	4405101	PVA Eye Spears	Sterile	100 (10/pouch)

Microsurgery

Invotec Number	Merocel [®] Number	Description		Qty/Box
22-70300	2218525	Instrument wipe	3.5" x 3.5"	20

Merocel[®] is a registered trademark of Medtronic-Xomed

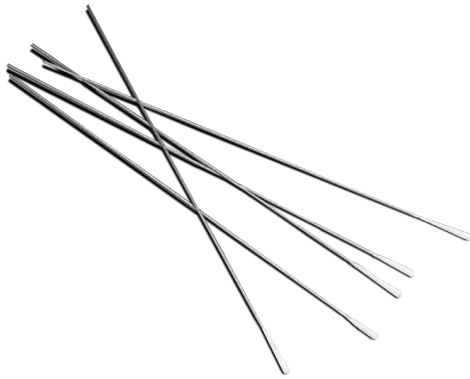

COTTON TIPPED APPLICATORS

- Pure cotton end
- Sterile packed - 5 per pouch

Number	Description		Qty/Box
2011898	Steel Applicator with Cotton Tip	0.9 mm x 150 mm	100

Anti-Fog



FOG GUARD™

Invotec's Fog-Guard™ anti-fog solution has been formulated, without alcohol, to provide excellent levels of anti fog protection from distortion for your delicate glass optics.

Number	Description		Qty/Box
30900	Kit- One (1) Screw top dispenser bottles (6 cc) and one (1) Green micropore wiping pad with adhesive backing, 4.3cm x 3.8cm (1 6/10" x 1 1/2")	Sterile	20 kits

Head Support



COMFORTFOAM™ HEADREST

- Flexible Positioning
- Protects Sensitive Skin
- Fire Retardant¹
- Enhanced Patient Stability

Number	Description		Qty/Box
26-71000	Comfortfoam™ sculpted head rest - Blue, with ET-Anesthesia Slot		1
26-72000	Comfortfoam™ sculpted head rest - Blue		1
26-73000	Comfortfoam™ sculpted head rest for child		1

¹Complies With California Technical Bulletin #117



Constructed of super-strong, heat resistant, (360°F, 160°C) ULTEM® material, the Invotec trays are designed to protect your valuable delicate instruments during sterilization. Offered in multiple sizes and complimented with tops, stackable trays, silicone finger mats and cradles, you can build your own custom instrument tray system.

Containers

Number	Length x Width x Depth	Description
T602575	6.0 x 2.5 x .75 inches	Base/Lid
T602512	6.0 x 2.5 x 1.25 inches	Base/Lid
T654075	6.5 x 4.0 x .75 inches	Base/Lid
T752575	7.5 x 2.5 x .75 inches	Base/Lid
T754075	7.5 x 4.0 x .75 inches	Base/Lid
T754015	7.5 x 4.0 x 1.5 inches	Base/Lid
T106075	10.0 x 6.0 x .75 inches	Base/Lid
T106015	10.0 x 6.0 x 1.5 inches	Base/Lid
T106020	10.0 x 6.0 x 1.5 inches	Base/Lid, second tray
T151015	15 x 10 x 1.5 inches	Base/Lid
T151010	15 x 10 x .75 inches	Large Tray, base/lid/mat
T151025	15 x 10 x 1.5 inches	Large Tray, base/lid/mat
T151026	15 x 10 x 1.5 inches	Large Tray, base/lid/insert/mats
T162615	16 x 2.6 x 1.5 inches (40.6cm long)	Scope Tray, base/lid
T186515	18 x 6.5 x 1.5 inches (45.7cm long)	Scope Tray, base/lid
T186530	18 x 6.5 x 3.0 inches (45.7cm long)	Scope Tray, base/lid
T-122615	12" x 2.6" x 1.54"	Scope tray, lid/cradles for two 185mm rod lens scopes

Silicone Mats

Number	Length x Width	Description
T602513	6.0 x 2.5 inches	Finger Mat
T654013	6.0 x 4.0 inches	Finger Mat
T752513	7.5 x 2.5 inches	Finger Mat
T754013	7.5 x 4.0 inches	Finger Mat
T106023	10.0 x 6.0 inches	Finger Mat
T151023	15 x 10 inches	Finger Mat
T162613	16 x 2.6 inches	Finger Mat
T186513	18 x 6.5 inches	Finger Mat
T186533	18 x 6.5 x 3.0 inches	Finger Mat

Silicone Cradles

Catalog No.	Description	Instrument Application
T237590	3 slot insert opposite, triple slot	Keeps 3 forceps separated
T237591	Single slot bar, round cut	Knife / instrument
T237592	Double slot bar, round cut	Knife / instrument
T237593	Triple slot bar, round cut	Knife / instrument
T237596	6 slot insert opposite triple slot	Keeps 3 forceps separated
T261691	Scope round cut, 9 and 12mm	Endoscope(s)
T261692	Scope round cut, 9mm (2)	Endoscope(s)
T387512	12 slot insert holding 6 forceps	Keeps 6 forceps separated
T387592	Double slot bar for large tray	Knives / instruments
T387593	Triple slot bar for large tray	Knives / instruments
T387594	Four slot bar for large tray	Knives / instruments
T387595	Five slot bar for large tray	Knives / instruments
T387596	6 slot insert for 6 forceps	Keeps 6 forceps separated

RHINOLOGY & COSMETIC INSTRUMENTS

R&CS ACC

DIS

OTO ACC

OSS

LAR ACC

SPE ACC

RHINS

PSB

OTO INS

LAR INS

ORO/NAS INS

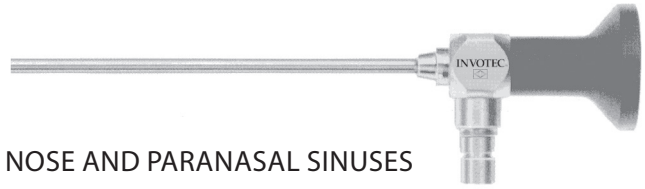

TELESCOPES FOR NOSE AND PARANASAL SINUSES

Number	Description	Diameter	Working Length
10-0036-00	Straight Forward Wide Angle Telescope	0° 2.7 mm	110 mm autoclavable
10-0037-00	Straight Forward Wide Angle Telescope	30° 2.7 mm	110 mm autoclavable
10-0038-00	Straight Forward Wide Angle Telescope	70° 2.7 mm	110 mm autoclavable

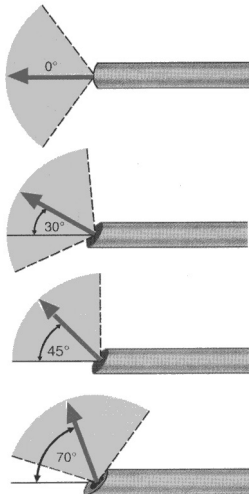

Number	Description	Diameter	Working Length
10-0045-00	Straight Forward Wide Angle Telescope	0° 4 mm	175 mm autoclavable
10-0046-00	Straight Forward Wide Angle Telescope	30° 4 mm	175 mm autoclavable
10-0086-00	Straight Forward Wide Angle Telescope	45° 4 mm	175 mm autoclavable
10-0047-00	Straight Forward Wide Angle Telescope	70° 4 mm	175 mm autoclavable

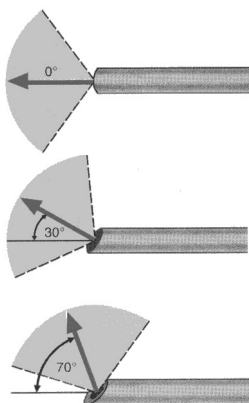

Number	Description	Diameter	Working Length
10-0039-00	Straight Forward Wide Angle Telescope	0° 2.7 mm Ø	175 mm autoclavable
10-0040-00	Straight Forward Wide Angle Telescope	30° 2.7 mm Ø	175 mm autoclavable
10-0041-00	Straight Forward Wide Angle Telescope	70° 2.7 mm Ø	175 mm autoclavable

TELESCOPE HANDLES

Number	Description	Length	Working Length
S40213	Telescope Handle round	6.5 cm	110 mm



Number	Description	Length	Working Length
S40211	Flat Handle	straight forward telescopes up to 4 mm Ø	11 cm 175 mm



S40212	Round Handle	forward-oblique and lateral telescopes up to 4 mm Ø	11 cm 175 mm
--------	--------------	---	--------------



S41100	Protection Tube for Sinuscopy Telescopes		
--------	--	--	--

ENDOSCOPE TROCAR AND CANNULA

Number	Description		OuterØ	Cannula length
S18400	Trocar and Cannula for Sinuscopy with billshaped beak	for use with 4 mm telescopes	5 mm	8.5 cm
S18500	Trocar and Cannula for Sinuscopy with oblique beak	for use with 4 mm telescopes	5 mm	8.5 cm
S18503	Trocar and Cannula for Sinuscopy with oblique beak	for use with 2.7 mm telescopes	3.3 mm	7.5 cm
S18504	Trocar and Cannula for Sinuscopy with oblique beak	for use with 3 mm telescopes	4 mm	7.5 cm

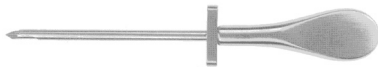

SUCTION IRRIGATION

Number	Description
S42800	Sheath for telescope 2.7mm, 190mm, 0°
S42830	Sheath for telescope 2.7mm, 190mm, 30°
S42870	Sheath for telescope 2.7mm, 190mm, 70°
S42900	Sheath for telescope 2.7mm, 140mm, 0°
S42930	Sheath for telescope 2.7mm, 140mm, 30°
S42970	Sheath for telescope 2.7mm, 140mm, 70°
S44100	Sheath for telescope 4.0mm, 180mm, 0°
S44130	Sheath for telescope 4.0mm, 180mm, 30°
S44145	Sheath for telescope 4.0mm, 180mm, 45°
S44170	Sheath for telescope 4.0mm, 180mm, 70°

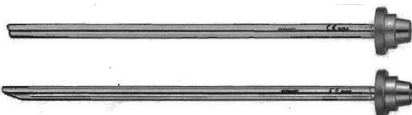

Number	Description
S52100	Pencil Grip Suction Irrigation Handle
S42830	Sheath for 2.7mm, telescopes 0-30°
S52930	Sheath for 4.0mm, telescope 0-30°
S52870	Sheath for 2.7mm. Telescope 70°
S52970	Sheath for 4.0mm, telescope 70°

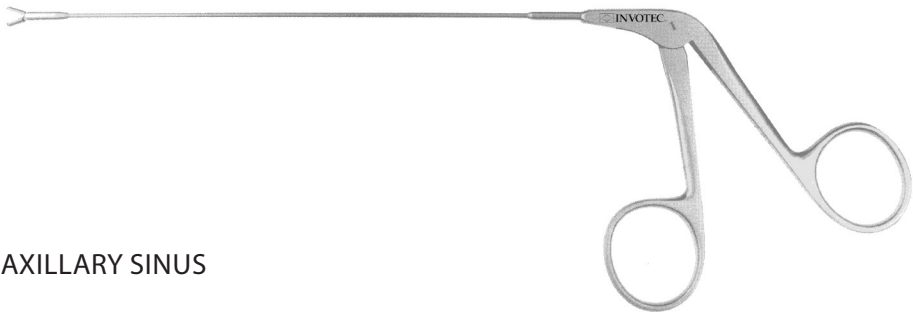



MAXILLARY SINUS

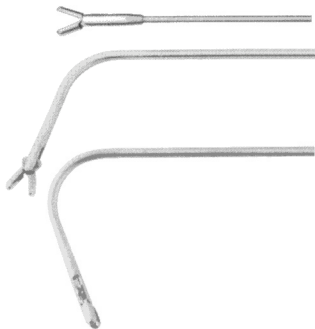

Number	Description	Sheath	Working Length
S15000	Biopsy and Grasping Forceps	double action oval cupped jaws 2.5 mm Ø	15 cm
S15070	Biopsy Forceps	double action oval cupped jaws, 3.0 mm Ø	angles down 70°
S15110	Biopsy Forceps	double action oval cupped jaws, 3.0 mm Ø	angles down 110°



ANTRUM GRASPING FORCEPS



Number	Description	Working Length
S15500	Antrum Grasping Forceps, (Heuwieser style) retrograde opening jaws 120°	10 cm

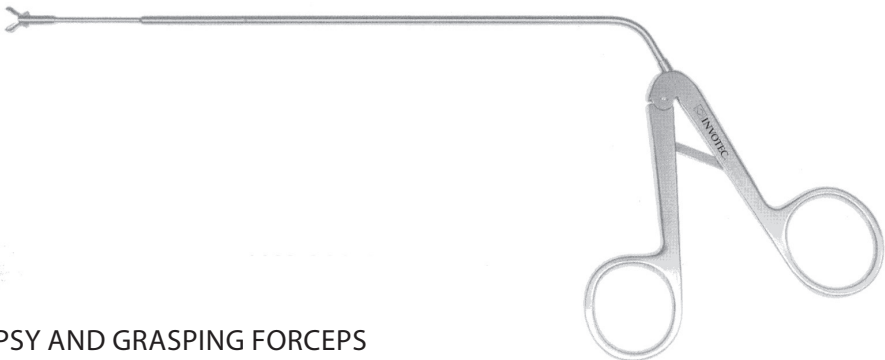

BIOPSY AND GRASPING FORCEPS



Number	Description	Working Length
S15005	Biopsy and Grasping Forceps with malleable sheath end	double action oval cupped jaws 4mm Ø with vertical opening 18 cm

THROUGH-CUTTING FRONTAL SINUS PUNCH FORCEPS

Number	Description	Diameter			Working Length
S36201	Double action cup jaws	2 mm	55° upturned	vertical opening	14.5 cm
S36202	Double action cup jaws	2 mm	55° upturned	horizontal opening	14.5 cm
S36203	Double action cup jaws	2 mm	90° upturned	vertical opening	14.5 cm
S36204	Double action cup jaws	2 mm	90° upturned	horizontal opening	14.5 cm

GIRAFFE FORCEPS

Number	Description	Diameter		
S35401	Double action cup jaws	3 mm	55° upturned	vertical opening
S35402	Double action cup jaws	3 mm		horizontal opening
S35403	Double action cup jaws	2 mm		vertical opening
S35404	Double action cup jaws	2 mm		horizontal opening
S35413	Double action cup jaws	4 mm		vertical opening
S35414	Double action cup jaws	4 mm		horizontal opening

Number	Description	Diameter		
S35405	Double action cup jaws	2 mm	90° upturned	vertical opening
S35406	Double action cup jaws	2 mm		horizontal opening
S35409	Double action cup jaws	4 mm		vertical opening
S35410	Double action cup jaws	4 mm		horizontal opening



BIOPSY FORCEPS



Number	Description	Diameter		
S35110	Oval double action cupped jaws	2.6 mm	110° backwards cutting	horizontal opening
S35111	Oval double action cupped jaws	2.6 mm	110° backwards cutting	vertical opening
S35170	Oval double action cupped jaws	2.6 mm	70° upturned	horizontal opening
S35171	Oval double action cupped jaws	5.6 mm	70° upturned	vertical opening
S35114	Oval double action cupped jaws	4 mm	110° backwards cutting	horizontal opening
S35124	Oval double action cupped jaws	4 mm	110° backwards cutting	vertical opening

PEAR-SHAPED POLYP GRASPING FORCEPS



Number	Description			
S35300	Jaws 3 x 1.5 mm	pear-shaped	80° upturned	horizontal opening
S35304	Jaws 3 x 1.5 mm	pear-shaped	45° upturned	upturned
S35301	Jaws 3 x 1.5 mm	pear-shaped	80° upturned	sheath curved left
S35302	Jaws 3 x 1.5 mm	pear-shaped	80° upturned	sheath curved right

BLAKESLEY NASAL FORCEPS

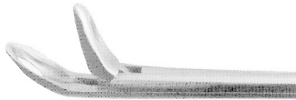

Number	Description	Diameter	Size	Working Length
S30000	Blakesley nasal forceps	Straight	0 = 3 mm	11 cm
S30001	Blakesley nasal forceps	Straight	1 = 3.5 mm	11 cm
S30002	Blakesley nasal forceps	Straight	2 = 4 mm	11 cm
S30003	Blakesley nasal forceps	Straight	3 = 5 mm	11 cm

BLAKESLEY-WILDE NASAL FORCEPS

Number	Description	Diameter	Size	Working Length
S30100	Blakesley-Wilde nasal forceps	45° upcurved	0 = 3 mm	11 cm
S30101	Blakesley-Wilde nasal forceps	45° upcurved	1 = 3.5 mm	11 cm
S30102	Blakesley-Wilde nasal forceps	45° upcurved	2 = 4 mm	11 cm
S30103	Blakesley-Wilde nasal forceps	45° upcurved	3 = 5 mm	11 cm

BLAKESLEY-WILDE NASAL FORCEPS

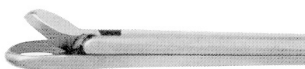
Number	Description	Diameter	Size	Working Length
S30200	Blakesley-Wilde nasal forceps	90° upcurved	0 = 3 mm	11 cm
S30201	Blakesley-Wilde nasal forceps	90° upcurved	1 = 3.5 mm	11 cm
S30202	Blakesley-Wilde nasal forceps	90° upcurved	2 = 4 mm	11 cm
S30203	Blakesley-Wilde nasal forceps	90° upcurved	3 = 5 mm	11 cm

BLAKESLEY THROUGH-CUT FORCEPS

Number	Description	Diameter	Bite	Size	Working Length
S35800	Blakesley through-cut forceps	Straight	2 mm	0 = 3 mm	11 cm
S35801	Blakesley through-cut forceps	Straight	2.5 mm	1 = 3.5 mm	11 cm
S35802	Blakesley through-cut forceps	Straight	3.0 mm	2 = 4 mm	11 cm

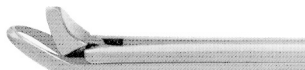

S35900	Blakesley through-cut forceps	45° upcurved	2 mm	0 = 3 mm	11 cm
S35901	Blakesley through-cut forceps	45° upcurved	2.5 mm	1 = 3.5 mm	11 cm
S35902	Blakesley through-cut forceps	45° upcurved	3.0 mm	2 = 4 mm	11 cm



BLAKESLEY ANTRUM FORCEPS

Number	Description	Tube Shaft	Tip	Working Length
S30500	Blakesley antrum forceps	tube shaft	curved left	10 cm
S30600	Blakesley antrum forceps	tube shaft	curved right	10 cm

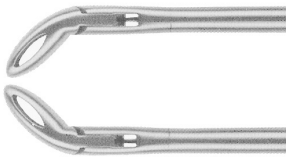

POLYP GRASPING FORCEPS

Number	Description	Size	Working Length
S30400	Polyp grasping forceps	60° upcurved round spoon 6 x 14 mm	11 cm

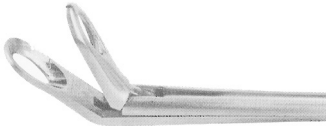

HELMS NASAL FORCEPS

Number	Description	Tip	Working Length
S30700	Helms nasal forceps	oval cupped spoon curved left	13 cm
S30800	Helms nasal forceps	oval cupped spoon curved right	13 cm

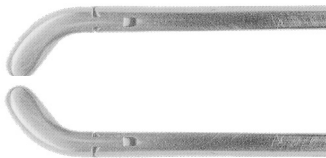

TAKAHASHI NASAL FORCEPS

Number	Description	Tip	Working Length
S27001	Takahashi nasal forceps	straight spoon 3 x 10 mm	11 cm
S27002	Takahashi nasal forceps	30° upturned spoon 3 x 10 mm	11 cm

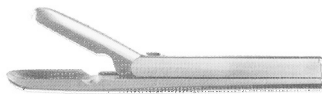

STRUYCHEN NASAL CUTTING FORCEPS

Number	Description	Working Length
S27500	Struychen nasal cutting forceps	11 cm



HARTMANN NASAL CUTTING FORCEPS

Number	Description	Size	Working Length
S29001	Hartmann nasal cutting forceps	1	11 cm
S29002	Hartmann nasal cutting forceps	2	11 cm
S29003	Hartmann nasal cutting forceps	3	11 cm
S29004	Hartmann nasal cutting forceps	4	11 cm



STRUEMPEL

Number	Description	Tip	Working Length
S30300	Struempel-Voss nasal forceps	45° upcurved extra delicate	11 cm
S41000	Struempel nasal forceps	straight oval cup-shaped jaws	10 cm
S41045	Struempel nasal forceps	45° upcurved oval cup-shaped jaws	110 cm
S41090	Struempel nasal forceps	90° upcurved oval cup-shaped jaws	10 cm

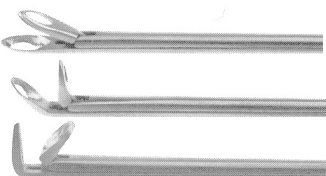

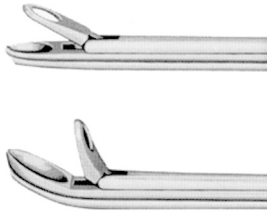
BLAKESLEY SUCTION FORCEPS

Number	Description		Size	Working Length
S37001	Blakesley suction forceps with suction channel	straight	1 = 3.5 mm	11 cm
S37002	Blakesley suction forceps with suction channel	straight	2 = 4 mm	11 cm
S37101	Blakesley suction forceps with suction channel	45° upturned	1 = 3.5 mm	11 cm
S37102	Blakesley suction forceps with suction channel	45° upturned	2 = 3.5 mm	11 cm

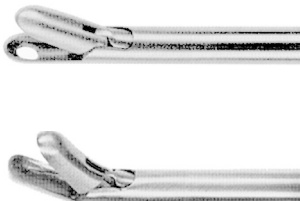
TAKAHASHI SUCTION FORCEPS

Number	Description		Size	Sheath Diameter	Working Length
S38001	Takahashi suction forceps with integrated suction channel	straight	1 = 3.5 mm	4 mm	10 cm
S38002	Takahashi suction forceps with integrated suction channel	straight	2 = 2.5 mm	4 mm	10 cm
S38101	Takahashi suction forceps with integrated suction channel	45° upturned	1 = 3.5 mm	4 mm	10 cm
S38102	Takahashi suction forceps with integrated suction channel	45° upturned	2 = 2.5 mm	4 mm	10 cm



BLAKESLEY SUCTION FORCEPS WITH INTEGRATED SUCTION CHANNEL



Number	Description	Size	Diameter	Working Length	
S36800	BLAKESLEY suction forceps with suction channel	straight	0 = 2.5 mm	4 mm	11 cm
S36801	BLAKESLEY suction forceps with suction channel	straight	1 = 3.5 mm	4 mm	11 cm
S36802	BLAKESLEY suction forceps with suction channel	straight	2 = 4 mm	4 mm	11 cm
S36900	BLAKESLEY suction forceps with suction channel	45° upcurved	0 = 2.5 mm	4 mm	10 cm
S36901	BLAKESLEY suction forceps with suction channel	45° upcurved	1 = 3.5 mm	4 mm	10 cm
S36902	BLAKESLEY suction forceps with suction channel	45° upcurved	2 = 4 mm	4 mm	10 cm



BLAKESLEY SUCTION FORCEPS FOR CHILDREN



Number	Description	Jaw Size	Sheath diameter	Working Length	
S36700	Blakesley suction forceps for children with integrated suction channel	straight	2.5 mm	2.7 mm	10 cm
S36745	Blakesley suction forceps for children with integrated suction channel	45° upcurved	2.5 mm	2.7 mm	10 cm

THROUGH CUTTING FORCEPS WITH INTEGRATED SUCTION CHANNEL

Number	Description	Bite	Working Length
S35200	Through cutting forceps with integrated suction channel	straight	2 mm 10 cm
S35201	Through cutting forceps with integrated suction channel	45° upcurved	2 mm 10 cm
S35204	Through cutting forceps with integrated suction channel	shaft 15° upcurved	2 mm 10 cm

FOKKENS BIOPSY FORCEPS



Number	Description	Bite	Working Length
S36000	Fokkens Biopsy Forceps	straight	3 mm Ø 8 cm
S36045	Fokkens Biopsy Forceps	45° upcurved	Round 3 mm Ø 11 cm



SUPER PUNCH THRU CUT FORCEPS

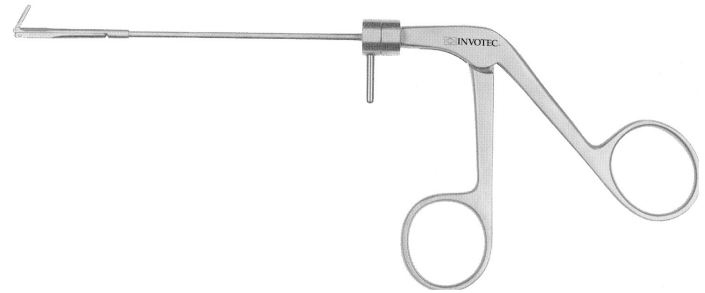
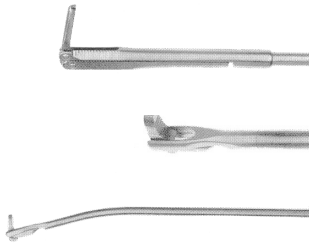

Number	Description		Bite	Size	Working Length
S36400	Super Punch Thru Cut forceps	straight	Oval 2 mm	0	13 cm
S36401	Super Punch Thru Cut forceps	straight	Oval 2.5 mm	1	13 cm
S36402	Super Punch Thru Cut forceps	straight	Oval 3 mm	2	13 cm
S36500	Super Punch Thru Cut forceps	upcurved	Oval 2 mm	0	13 cm
S36501	Super Punch Thru Cut forceps	upcurved	Oval 2.5 mm	1	13 cm
S36502	Super Punch Thru Cut forceps	upcurved	Oval 3 mm	2	13 cm

ROTATING BACK BITER

Number	Description	Bite	Working Length
S35015	Rotating Backbiting Antrum Punch, finger post facilitates 360° rotation	pediatric size: 1.5 mm	10 cm
S35025	Rotating Backbiting Antrum Punch, finger post facilitates 360° rotation	2.5 mm	10 cm
S35050	Toby micro backbiter finger post facilitates 360° rotation	curved down	10 cm

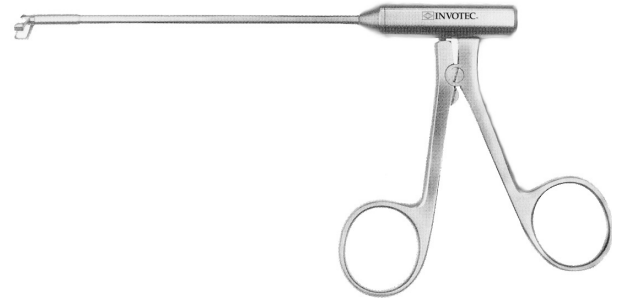
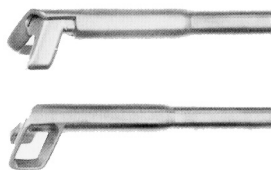

STAMMBERGER TYPE SIDEBITING ANTRUM PUNCH

Number	Description	Bite	Working Length
S34801	Sidebiting antrum punch	leftside downward and forward	throughcut 10 cm
S34802	Sidebiting antrum punch	rightside downward and forward	throughcut 10 cm

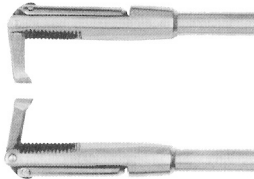

BACKBITING ANTRUM

Number	Description	Bite	Working Length
S35000	Antrum Punch - adult size	upside backwards cutting	2.5 mm 10 cm
S35001	Antrum Punch - adult size	left side backwards cutting	2.5mm 10 cm
S35002	Antrum Punch - adult size	right side backwards cutting	2.5mm 10 cm



Number	Description	Bite	Working Length
S35020	Antrum Punch - pediatric	upside backwards cutting	1.5 mm 10 cm
S35021	Antrum Punch - pediatric	left side backwards cutting	1.5 mm 10 cm
S35022	Antrum Punch - pediatric	right side backward cutting	1.5 mm 10 cm

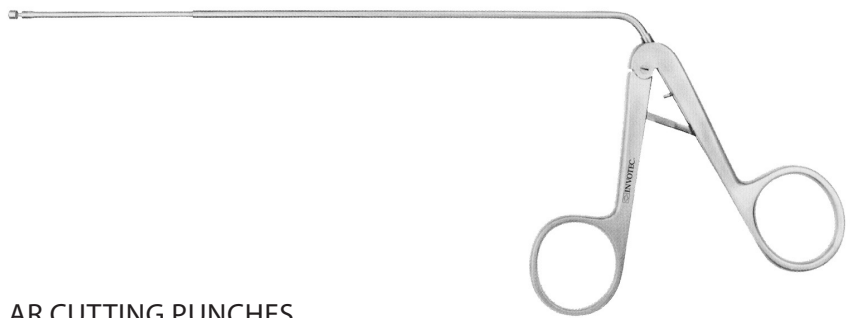

CIRCULAR CUTTING PUNCHES

Number	Description	Diameter	Working length
S34935	Circular Cutting Punch cutting in a full circle of 360°	3.5 mm	18 cm
S34945	Circular Cutting Punch cutting in a full circle of 360°	4.5 mm	18 cm
S34965	Circular Cutting Punch cutting in a full circle of 360°	65° upturned 3.5 mm	17 cm
S34975	Circular Cutting Punch cutting in a full circle of 360°	4.5 mm	18 cm

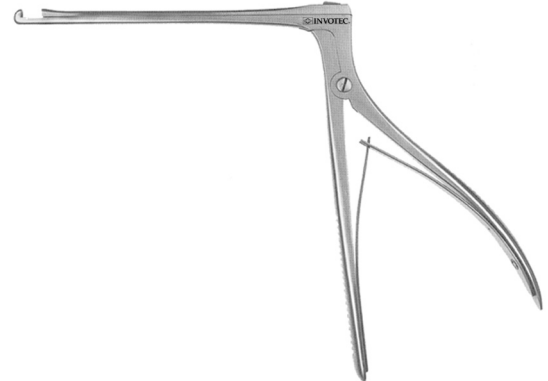
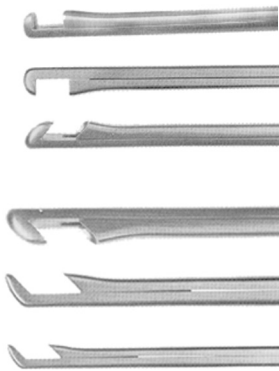

BIOPSY FORCEPS

Number	Description		Width	Working Length
S12001	HAJEK Sphenoid Punch	90° upbiting	4 mm	14 cm
S12002	HAJEK Sphenoid Punch	90° downbiting	4 mm	14 cm
S12201	HAJEK Sphenoid Punch	45° upbiting backward	4 mm	14 cm
S12202	HAJEK-KOFLER Sphenoid Punch	45° downbiting backward	4 mm x 4 mm	14 cm
S12301	HAJEK-KOFLER Sphenoid Punch	45° upbiting forward	4 mm x 4 mm	14 cm
S12302	HAJEK-KOFLER Sphenoid Punch bite 2mm x 2mm	45° upbiting forward	4 mm x 4 mm	14 cm



BEYER ANTRUM PUNCH

Number	Description		Width	Working Length
S12500	BEYER Antrum Punch	90° throughbiting upwards	2 mm	9 cm
S12600	BEYER Antrum Punch	90° throughbiting backward	2 mm	9 cm

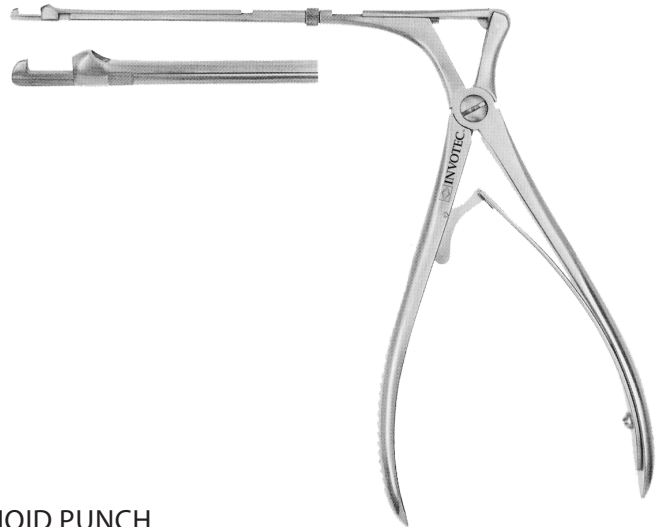

HAJEK-KOFLER ROTATABLE SPHENOID PUNCH

Number	Description	Working Length
S13000	Hajek-Kofler Sphenoid punch reversible 360° slender pattern	17 cm



ROTATABLE SPHENOID PUNCH

Number	Description	Bite	Working Length
S13100	Sphenoid punch reversible 360° throughcutting slender pattern	2 mm	14.5 cm

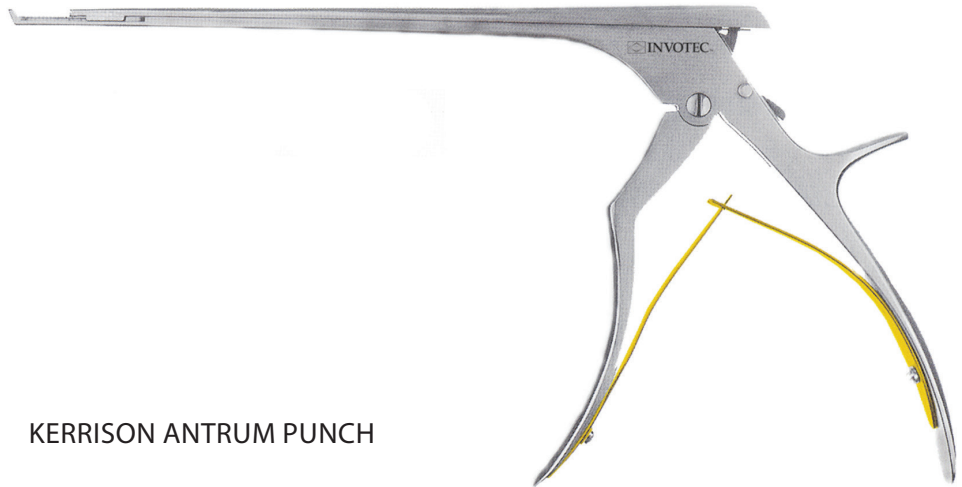
KERRISON ANTRUM PUNCH

Number	Description		Bite	Working Length
S12902	FS-Kerrison sphenoid punch	90° upbiting	2 mm	18 cm
S12903	FS-Kerrison sphenoid punch	90° upbiting	3 mm	18 cm

S12922	FS-Kerrison sphenoid punch	40° upbiting	2 mm	18 cm
S12923	FS-Kerrison sphenoid punch	40° upbiting	3 mm	18 cm

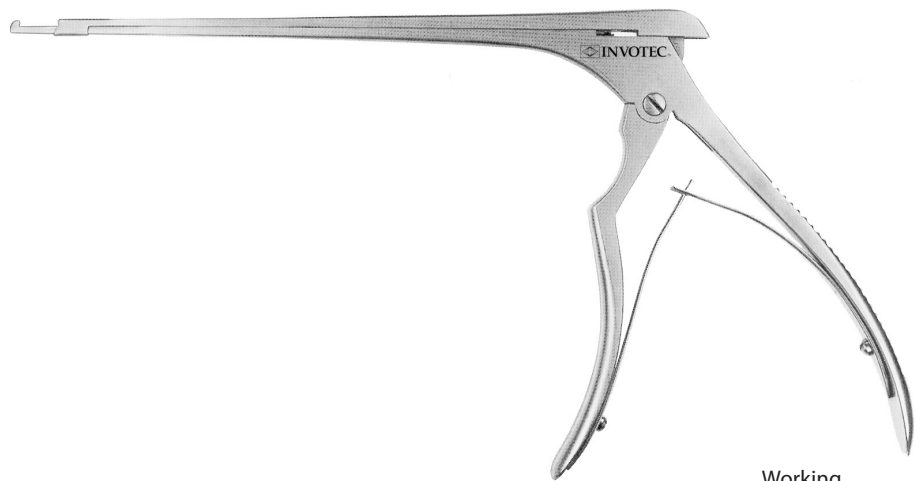

Number	Description		Bite	Working Length
S12402	Antrum punch	throughcutting	2 mm	18 cm
S12403	Antrum punch	throughcutting	3 mm	15 cm



S13100	Sphenoid punch - slender pattern	reversible 360°	2 mm	14.5cm
--------	----------------------------------	-----------------	------	--------

Number	Description
S12410	Stylet, for removal of the bone material from the deposit of S12402 and S12403

S12800	Ethmoid punch	backward cutting	2.5 mm	17 mm
--------	---------------	------------------	--------	-------

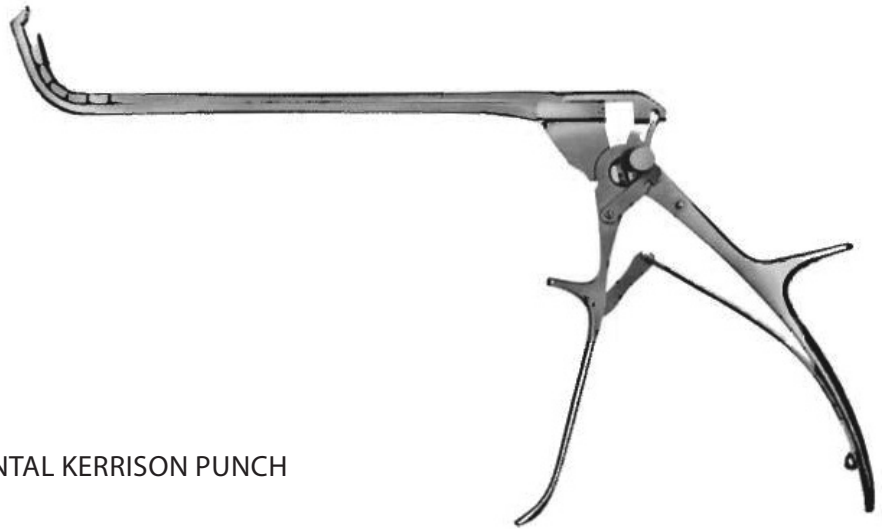

FRONTAL KERRISON PUNCH

Number	Description			Bite	Working Length
S12602	Frontal sinus punch	70° up	40° up biting forward	2 mm	17.5 cm
S12603	Frontal sinus punch	70° up	40° up biting forward	mm	17.5 cm

INTRANASAL SCISSORS

Number	Description				Working Length
S26200	Nasal scissors	serrated blades		straight	13 cm
S26201	Nasal scissors	serrated blades		curved left	13 cm
S26202	Nasal scissors	serrated blades		curved right	13 cm
S26210	Nasal scissors - small	serrated blades	3.5 mm	straight	12 cm
S26211	Nasal scissors - small	serrated blades	3.5 mm	curved right	12 cm
S26212	Nasal scissors - small	serrated blades	3.5 mm	curved left	12 cm

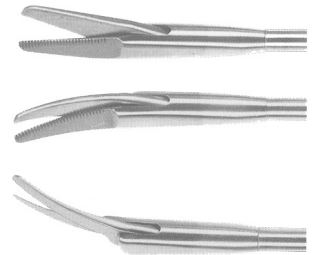
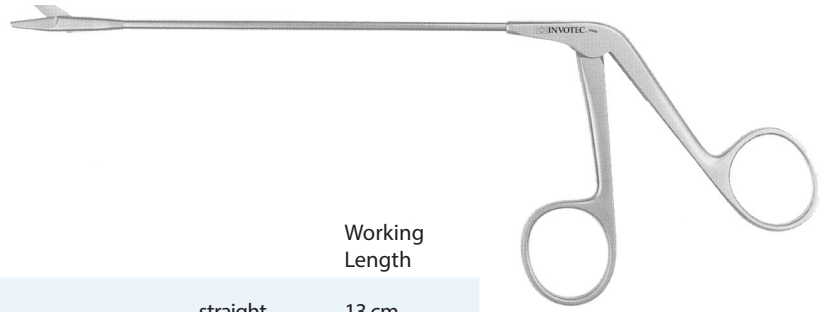
EYMANN NASAL SCISSORS

Number	Description				Working Length
S26000	Heymann nasal scissors	smooth blades	straight		9.5 cm
S26100	Heymann nasal scissors	serrated blades	straight		9.5 cm
S26101	Heymann nasal scissors	smooth blades	curved left		9.5 cm
S26102	Heymann nasal scissors	smooth blades	curved right		9.5 cm
S26009	Heymann nasal scissors	serrated blades	straight	small size	9 cm
S26011	Heymann nasal scissors	serrated blades	straight	small size	11 cm

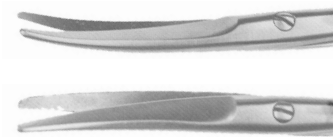

Number	Description			Working Length
S42000	BELLUCCI Scissors		straight	10 cm

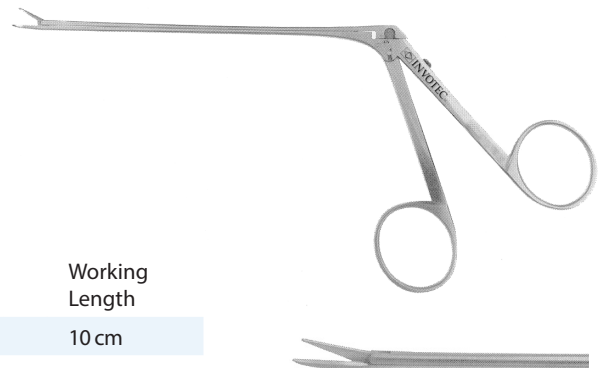



Number	Description		Working Length
R40700	Caplan septum scissors	straight	22 cm
R40600	Caplan septum scissors	angled	22 cm

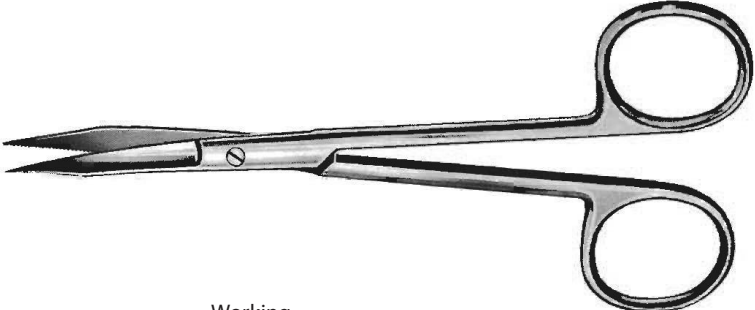

Number	Description					Working Length
R68210	Goldman scissors	Fox	tenotomy	serrated	straight	13 cm
R68310	Goldman scissors	Fox	tenotomy	serrated	curved	13 cm
R68413	Goldman scissors	Fox	tenotomy	TC supercut	straight	13 cm
R68613	Goldman scissors	Fox	tenotomy	TC supercut	curved	13 cm

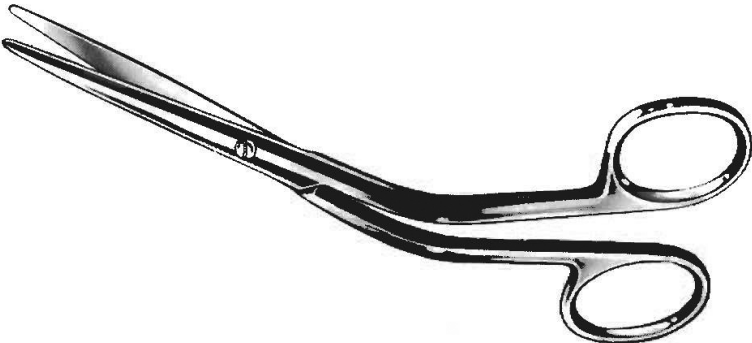

Number	Description		Working Length
R39100	Cottle dorsal scissors	angular	16 cm

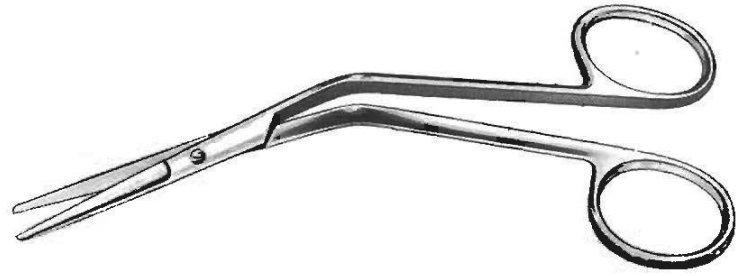

Number	Description	Working Length
R39000	Fomon dorsal scissors angular delicate	13.5 cm
R39001	Fomon dorsal scissors angular standard pattern	13.5 cm
R38612	Fomon lower lateral curved scissors	13.5 cm

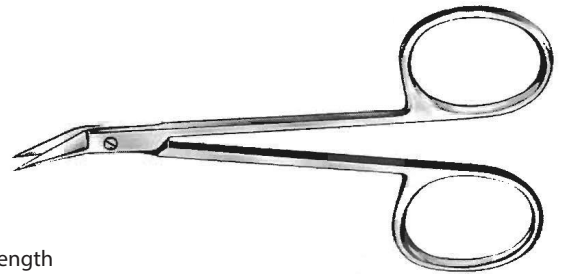

Number	Description	Working Length
R38410	Wilmer Angled sh/sh scissors	10 cm

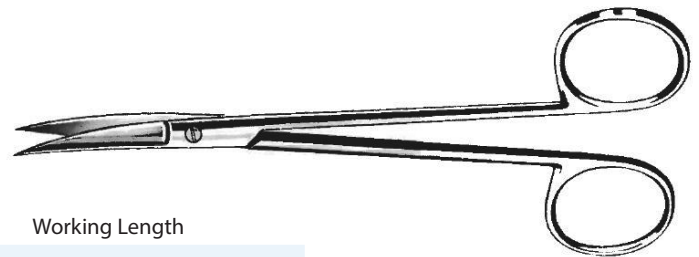

Number	Description	Working Length
R76514	Joseph scissors straight	14 cm
R76614	Joseph scissors curved	14 cm

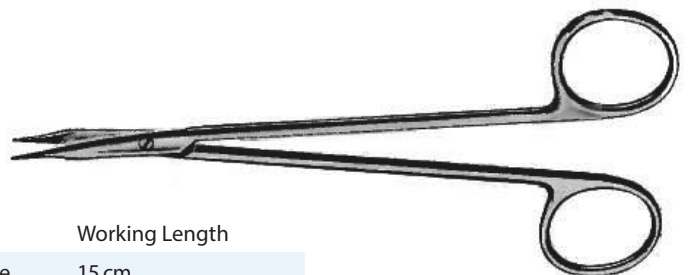

Number	Description	Working Length
R79615	Reynolds dissection scissors curved delicate	15 cm

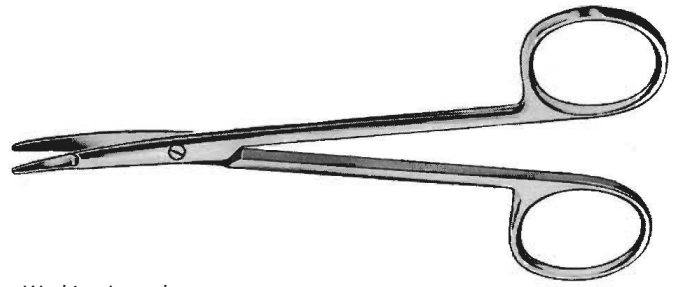

Number	Description	Working Length
R38712	Kilner (Ragnell) scissors curved flat tips	12 cm

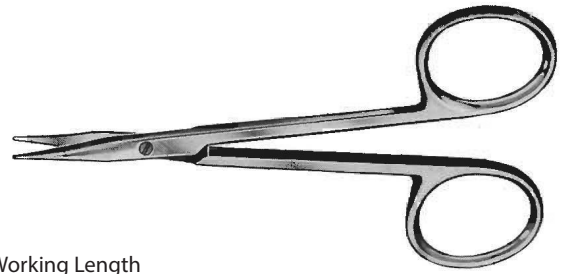

Number	Description	Working Length
R68210	Stevens Tenotomy scissors straight blunt	11.5 cm
R68310	Stevens Tenotomy scissors curved blunt	11.5 cm
R68411	Stevens Tenotomy scissors straight sharp	11.5 cm
R68410	Stevens Tenotomy scissors straight curved	11.5 cm

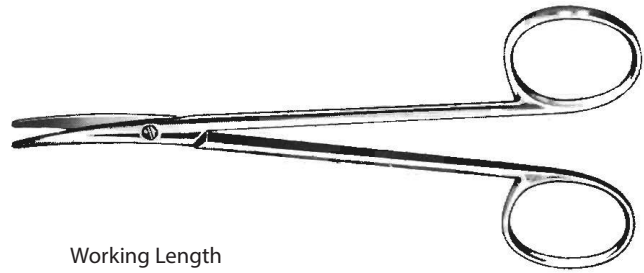

Number	Description	Working Length
R77010	Strabismus scissors blunt/blunt straight	10.5 cm
R77110	Strabismus scissors blunt/blunt curved	10.5 cm
R77212	Strabismus scissors blunt/blunt straight	11.5 cm
R77312	Strabismus scissors blunt/blunt curved	11.5 cm

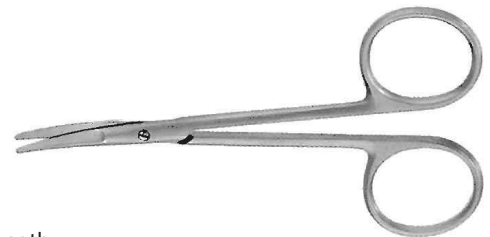

Number	Description	Working Length
R047712	Kaye Blepharoplasty scissors	11.5 cm

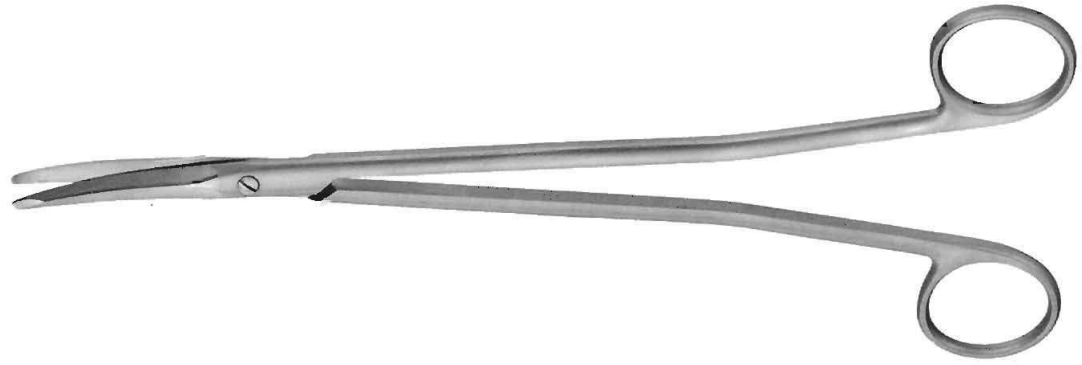

Number	Description	Working Length
R47519	Gorney facelift scissors	19 cm

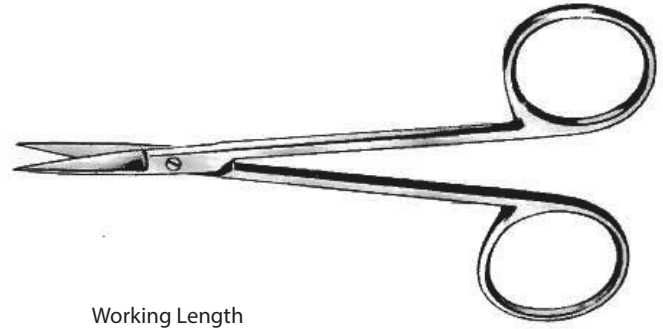

Number	Description	Blade Type	Tip Type	Working Length
R77510	Iris scissors	sharp/sharp	straight	10.5 cm
R77610	Iris scissors	sharp/sharp	curved	10.5 cm
R77712	Iris scissors	sharp/sharp	straight	11.5 cm
R77812	Iris scissors	sharp/sharp	curved	11.5 cm

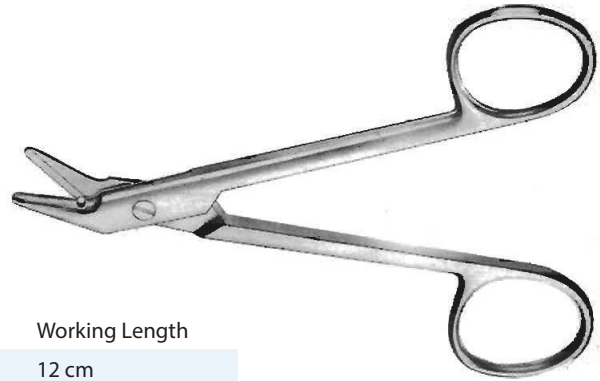

Number	Description	Working Length
R77901	Wire cutter universal	12 cm



Number	Description	Working Length
R13000	Freer Mucosa knife "D"	15 cm



Number	Description	Diameter	Working Length
R19001	Ballenger swivel knife bayonet	3 mm	20 cm
R19002	Ballenger swivel knife bayonet	4 mm	20 cm
R65015	Ballenger swivel knife bayonet	5 mm	20 cm
R65003	Ballenger swivel knife straight	3 mm	20 cm
R65004	Ballenger swivel knife straight	4 mm	20 cm
R65005	Ballenger swivel knife straight	5 mm	20 cm



Number	Description	Working Length
S03000	Cottle nasal knife rounded edges	15 cm



Number	Description	Working Length
S32000	Masing nasal knife slight curve round tip	13 cm



Number	Description
R29003	#3 Knife Handle



R29007	#7 Knife Handle
--------	-----------------



Number	Description	Working Length
R71065	Maltz cartilage knife angled	16 cm



Number	Description	Working Length
R353600	Fomon double-edge knife curved blunt tip	16 cm



Number	Description	Working Length
R34000	Joseph button-end knife straight	15 cm



R34100	Joseph-Converse button-end knife (Bistory) curved	15 cm
--------	---	-------



R35000	Joseph nasal knife straight pointed tip	15 cm
--------	---	-------



R35100	Joseph nasal knife curved pointed tip	15 cm
--------	---------------------------------------	-------



R35200	Joseph nasal knife straight blunt tip	15 cm
--------	---------------------------------------	-------



R35300	Joseph nasal knife curved blunt tip	15 cm
--------	-------------------------------------	-------



R71060	Joseph angled cartilage knife (Hockey Stick)	15 cm
--------	--	-------

JOSEPH NASAL SAW

Number		Working Length
R48100	straight	19 cm
R48001	bayonet	19 cm
R48002	bayonet	19 cm
R76022	bend to left	17 cm
R76021	bend to right	17 cm

FREER SEPTAL CHISEL

Number		Working Length
R20001	straight	16 cm
R20002	curved	16 cm

BALLENGER "V" SEPTAL GOUGE

Number	Width	Working Length
R60704	4 mm	16 cm
R60706	6 mm	16 cm
R60708	8 mm	16 cm

KILLIAN BAYONET NASAL GOUGE

Number	Working Length
R21000	17cm
R21100	17cm



COTTLE OSTEOTOME

Number		Width	Working Length
R07004	graduated straight	4 mm	18 cm
R07007	graduated straight	7 mm	18 cm
R07009	graduated straight	9 mm	18 cm
R07012	graduated straight	12 mm	18 cm

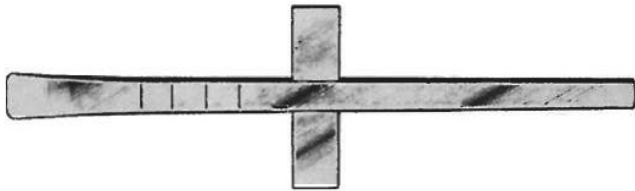

COTTLE DOUBLE GUARDED OSTEOTOME

Number	Width	Working Length
R61516	16 mm	18 cm



COTTLE DOUBLE GUARDED OSTEOTOME

Number	Width	Working Length
R10516	cross bar	18 cm



RUBIN DOUBLE GUARDED OSTEOTOME

Number	Width	Working Length
R06010	10 mm	18 cm
R06012	12 mm	18 cm
R06014	14 mm	18 cm



CINELLI DOUBLE GUARDED OSTEOTOME

Number	Width	Working Length
R060510	10 mm	18 cm
R060512	12 mm	18 cm
R060514	14 mm	18 cm
R060516	16 mm	18 cm



FOMON SINGLE GUARDED CHISEL

Number	Width	Working Length
R63904	4 mm	17 cm
R63905	5 mm	17 cm
R63906	6 mm	17 cm
R63907	7 mm	17 cm

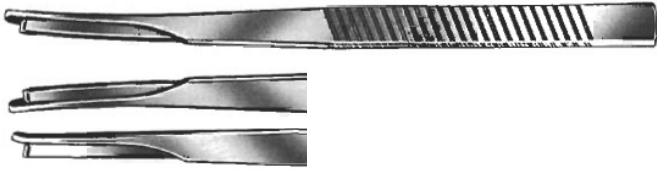
MASING SINGLE GUARDED CHISEL

Number		Working Length
R10000	straight	17.5 cm
R10001	curve left	17.5 cm
R10002	curve right	17.5 cm

CONVERSE SINGLE GUARDED OSTEOTOME

Number		Working Length
R07900	straight	19 cm
R07901	left	19 cm
R07902	right	19 cm

SILVER SINGLE GUARDED OSTEOTOME

Number	Width	Working Length
S12500	straight	18 cm
S12501	left	18 cm
S12502	right	18 cm

NEIVERT SINGLE GUARDED OSTEOTOME

Number		Working Length
R12000	straight	20 cm
R12001	curved	20 cm
R12002	curved	20 cm

WEST CHISEL

Number	Width	Working Length
R11000	4 mm	18 cm

WEST GOUGE



Number	Width	Working Length
R11100	4 mm	18 cm

MINI OSTEOTOME

Number	Width	Working Length
R07602	2 mm	18 cm
R07603	3 mm	18 cm

FREER ELEVATOR



Number	Description		Working Length
N15000	double-ended	USA Model	20 cm
R15100	double-ended	sharp/blunt	18 cm

GORNEY SUCTION ELEVATOR

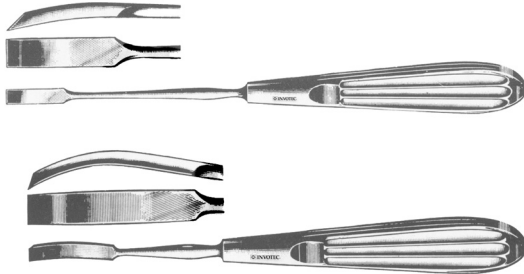
Number	Description		Working Length
S05800	Elevator styllet	3mm tip	19 cm

LEMPERT JOSEPH ELEVATOR

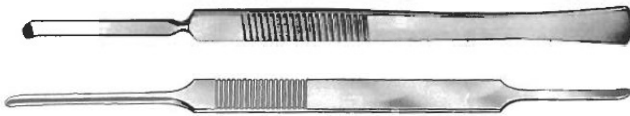
Number	Description	Width	Working Length
R26052	straight	2 mm	20 cm
R26057	straight	3 mm	20 cm
R26058	curved	3 mm	20 cm
R26070	wide	6 mm	20 cm
R26071	wide	6 mm	18 cm

MCKENTY ELEVATOR

Number	Description	Width	Working Length
R02004	single ended	4 mm	14.5 cm
R02005	single ended	5 mm	14.5 cm
R02500	double-ended		21.5 cm

KILLIAN SEPTUM ELEVATOR

Number	Description		Working Length
R16000	sharp/blunt	short	18 cm
R16100	sharp/blunt	long	22cm

MASING ELEVATOR

Number	Description		Working Length
R05000	double-ended graduated	sharp/blunt	21.5 cm

COTTLE ELEVATORS

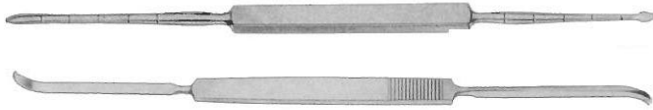

Number	Description	Working Length
R04500	double-ended, graduated blunt	21 cm
R05500	tunneling elevator	23 cm

PIERCE ELEVATOR



Number	Description	Working Length
R35821	double ended right - left	21 cm

PENNINTON ELEVATOR

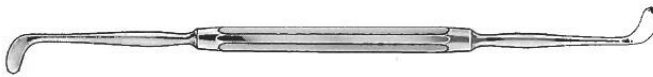

Number	Description	Working Length
R05600	double-ended right/left	21 cm

SEWALL ANTRUM



Number	Description	Working Length
R18000	Antrum elevator	19.5 cm

PROBES

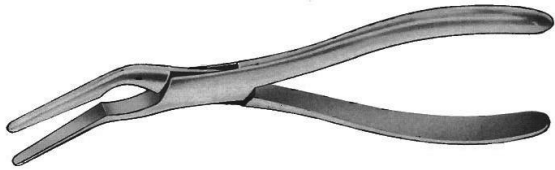

Number	Description	Working Length
S18725	Frontal sinus ostium seeker double-ended curved	19 cm
S18619	Maxillary sinus ostium seeker double-ended ball	19 cm

ASCH SEPTUM STRAIGHTENING FORCEPS

Number	Description	Working Length
R45000	Straightening forceps	23cm

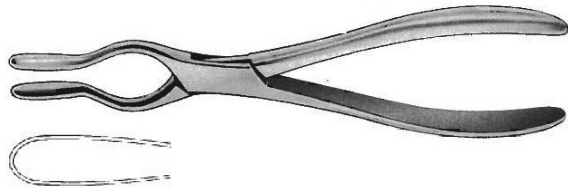
COTTLE-WALSHAM STRAIGHTENING FORCEPS

Number	Description	Working Length
R44000	Septum straightening forceps both sides	23 cm
R44101	Septum straightening forceps left	23 cm
R44102	Septum straightening forceps right	23 cm

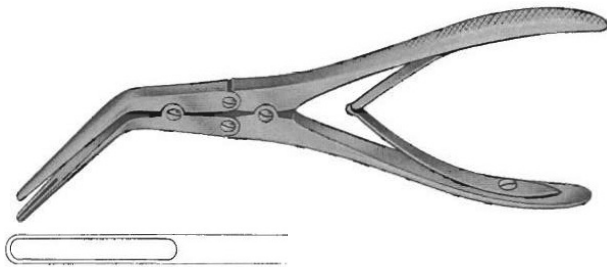
KRESSNER TURBINATE CRUSHING FORCEPS

Number	Description	Working Length
R47003	Crushing forceps 2.5 x 60 mm	20 cm
R47004	Crushing forceps 4 x 70 mm	20 cm
R47005	Crushing forceps 5 x 75 mm	20 cm

BOISE NASAL FRACTURE ELEVATOR

Number	Description	Working Length
R61000	"Butter Knife" blunt, oval	18 cm

GOLDMAN SEPTUM DISPLACER

Number	Description	Working Length
R61100	Septum displacer short	20 cm

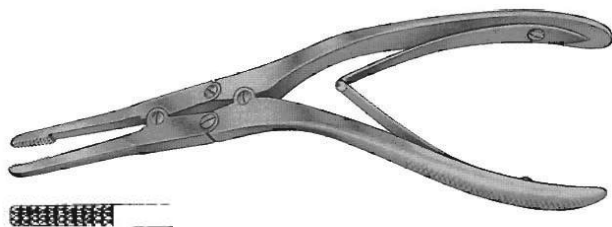
RUBIN SEPTUM MORCELIZER

Number	Description	Working Length
R42000	Rubin septum morcelizer double action	20 cm
R76570	Guard for Rubin septum morcelizer	



JANSON MIDDLETON DOUBLE ACTION FORCEPS

Number	Description	Working Length
R35600	Double action through-cut septal forceps	19 cm
R35500	Double action oval spoon nasal forceps	19 cm



STRUYCHEN THROUGH-CUT FORCEPS

Number	Description	Working Length
S27500	small through-cut forceps,	11 cm
S27501	large through-cut forceps,	11 cm

ANTRUM CURETTE

Number	Description			Working Length
S18001	Oval	size 1		19 cm
S18002	Oval	size 2		19 cm
S18003	Oval	size 3		19 cm
S18101	Round	small size		19 cm
S18102	Oblong	small size		19 cm
S18103	Oblong	large size		19 cm
S18203	Oblong	small size	forward cutting	19 cm
S18204	Oblong	small size	backward cutting	19 cm

SINUS FRONTAL CURETTE

Number	Description			Working Length
S18104	Oblong	small size	55° curved	19 cm
S18105	Oblong	small size	90° curved	19 cm

HALLE ANTRUM CURETTE



Number	Description			Working Length
S06001	malleable	size 1		21 cm
S06002	malleable	size 2		21 cm
S06003	malleable	size 3		21 cm

ANTRUM CURETTE

Number	Description		Working Length
S06101	curved left		21 cm
S06102	curved right		21 cm

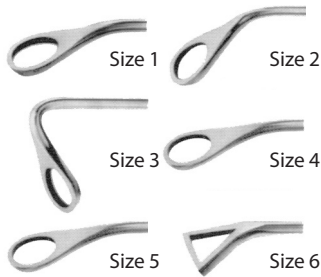

COAKLEY ANTRUM CURETTE



Number	Description	Working Length
S03001	size 1	17 cm
S03002	size 2	17 cm
S03003	size 3	17 cm
S03004	size 4	17 cm
S03005	size 5	17 cm
S03006	size 6	17 cm

FAULKNER ANTRUM CURETTE

Number	Description
S04000	Double ended

TIECK-HALLE NASAL SPECULUM

Number	Description	Working Length
S40000	For infants	13.5 cm
S43001	For adults	13.5 cm

BECKMAN ENDAURAL SPECULUM

Number	Description	Working Length
S06501	Small	15 cm
S06502	Medium	15 cm
S06503	Large	15 cm

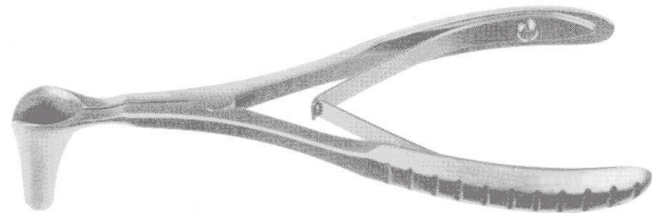
HARTMANN NASAL SPECULUM

Number	Description	Working Length
S43001	Large 35 mm	13.5 cm

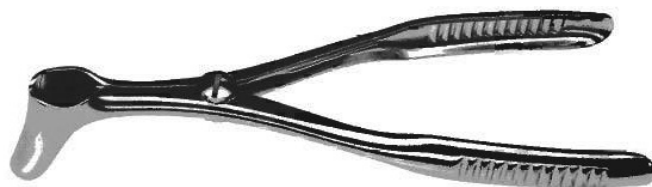
HARTMANN-HALLE NASAL SPECULUM

S41001	Size 1	15 cm
S41002	Size 2	15 cm
S41003	Size 3	15 cm

HARTMANN ECONOMY

Number	Description	Working Length
S43500	Office nasal speculum	14 cm

VIENNA NASAL SPECULUM

Number	Description	Working Length
S41601	Small	14.5 cm
S41602	Medium	14.5 cm
S41603	Large	14.5 cm



COTTLE NASAL SPECULUM WITH SET SCREW

Number	Description	Working Length
S00001	35 mm	15 cm
S00002	50 mm	15 cm
S00003	75 mm	15 cm
S00004	90 mm	15 cm



COTTLE NASAL SPECULUM WITHOUT SET SCREW

Number	Description	Working Length
S00101	35 mm	15 cm
S00102	50 mm	15 cm
S00103	75 mm	15 cm
S00104	90 mm	15 cm



KILLIAN NASAL SPECULUM

Number	Description	Working Length
S42001	35 mm	13 cm
S42002	50 mm	13 cm
S42003	75 mm	13 cm
S42004	90 mm	13 cm

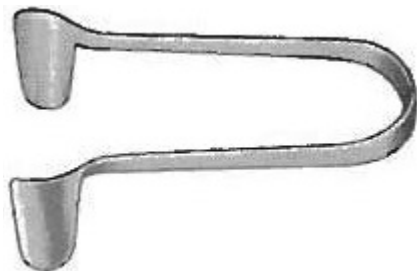

THUDICHUM (GOLDSMITH) SPRING NASAL SPECULUM

Number	Description
S41301	# 1
S41302	# 2
S41303	# 3

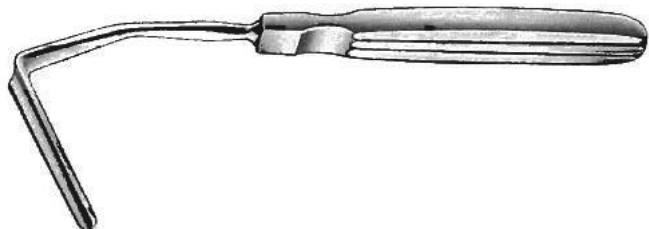

AUFRECHT NASAL RETRACTOR

Number	Description	Working Length
R22500	60 mm blade	16 cm
R22600	45 mm blade	16 cm

COTTLE ALAR RETRACTOR



Number	Description	Working Length
R19000	Vein retractor	15 cm
R19500	Vein retractor	15 cm



SENN RETRACTOR



Number	Description	Working Length
R65000	Sharp retractor	16 cm
R65100	Dull retractor	16 cm



REGNELL-DAVIS RETRACTOR

Number	Description	Working Length
R12514	Retractor	14 cm



PLASTICS RAKES

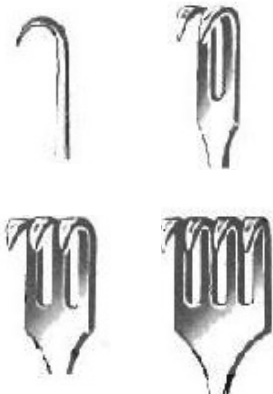

Number	Description	Working Length
R67004	Sharp retractor 4 prong	16 cm
R67003	Sharp retractor 3 prong	16 cm
R67002	Sharp retractor 2 prong	16 cm
R67001	Sharp retractor 1 prong	16 cm

Number	Description	Working Length
R68004	Dull retractor 4 prong	16 cm
R68003	Dull retractor 3 prong	16 cm
R68002	Dull retractor 2 prong	16 cm
R68001	Dull retractor 1 prong	16 cm



COTTLE RETRACTOR

Number	Description	Working Length
R18000	Retractor with 4 prong blunt, middle two teeth shortened	14 cm



COTTLE TENACULUM HOOK

Number	Description	Working Length
R15000C	delicate angled	16 cm
R151000	delicate curved	16 cm

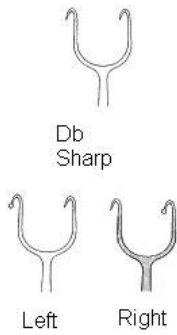

COTTLE NARES DOUBLE HOOK

Number	Description	Working Length
R16000	Sharp on Left, dull on right double hook	14 cm
R16100	Sharp on Right, dull on left double hook	14 cm
R16200	Sharp double hook	14 cm



COTTLE-NEIVERT KNIFE GUIDE/NARES DOUBLE BALL HOOK

Number	Description	Working Length
R20000	Large double ball hook/knife guide	20 cm



NEIVERT-MASING KNIFE GUIDE AND NARES RETRACTOR

Number	Description	Working Length
R20500	Knife guide and nares retractor	20 cm



FOMON DOUBLE BALL NASES HOOK

Number	Description	Working Length
R16600	Double ball nases hook 10 mm wide	16 cm,



CONVERSE DOUBLE END HOOK

Number	Description	Working Length
R24200	Alar double hook	12 cm



KILNER ALAR DOUBLE HOOK RETRACTOR

Number	Description	Working Length
R24300	double hook retractor	8 cm



COTTLE (MILLIARD) DOUBLE HOOK THIMBLE RETRACTOR

Number	Description
R22800	double hook thimble retractor



FREER-GUTHRIE MICRO DOUBLE HOOK

Number	Description	Working Length
R16400	Micro double hook sharp	15 cm

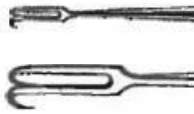

JOSEPH DOUBLE HOOK

Number	Description	Working Length
R16502	2 mm	16 cm
R16505	5 mm	16 cm
R16507	7 mm	16 cm
R16510	10 mm	16 cm

NERVE HOOK

Number	Description	Working Length
R61301	Blunt hook	18 cm

VOLKMAN BONE HOOK

Number	Description	Working Length
R05701	Sharp bone hook	21.5 cm



WEINER ANTRUM RASP

Number	Description	Working Length
R08101	Sharp rasp	18 cm



Number	Description	Working Length
R08102	Dull rasp	18 cm

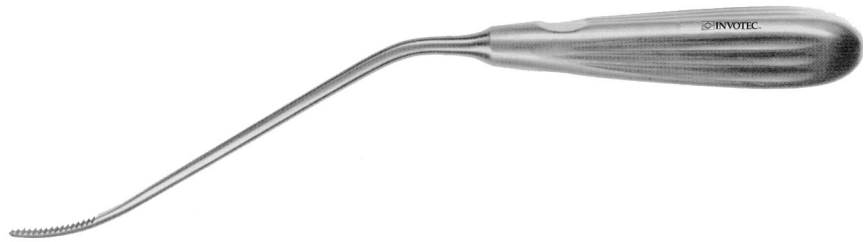

WATSON-WILLIAMS ANTRUM RASP

Number	Description	Working Length
R08500	Antrum Rasp	23 cm



FRONTAL SINUS RASP

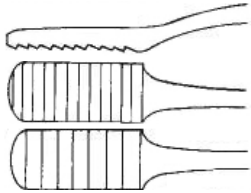

Number	Description	Working Length
R18110	Frontal Sinus Rasp strong pattern	
R18111	Frontal Sinus Rasp slender pattern	

LEWIS "SWEEPER" RASP

Number	Description			Working Length
R56600	Rasp "Sweeper"	Downcut	fine	18 cm
R56700	Rasp "Sweeper"	Downcut	coarse	18 cm

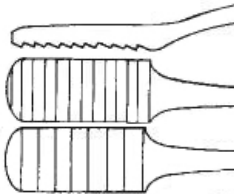
LEWIS "SWEEPER" TC RASP

Number	Description			Working Length
R36501	TC rasp "Sweeper"	Downcut	fine	18 cm
T36502	TC rasp "Sweeper"	Downcut	coarse	18 cm

COTTLE DOWNCUT RASP

Number	Description	Working Length
R54000	Downcut rasp	21 cm

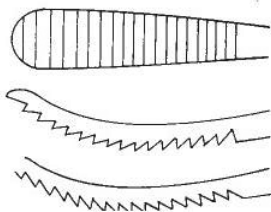
AUFRICHT CURVED GLABELLA RASP

Number	Description	Working Length
R54500	Push up cut rasp	21 cm
R54600	Pull down cut	21 cm

MALTZ SLOTTED RASP

Number	Description	Working Length
R53500	Slotted rasp	18 cm

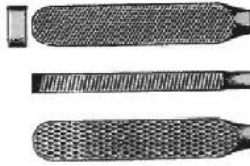

MASING - FOMON DOUBLE ENDED NASAL RASP

Number	Description	Working Length
R53000	Double ended nasal rasp # 1 & 2	21 cm
R53100	Double ended nasal rasp # 3 & 4	21 cm



MILLER-COLBURN DOUBLE ENDED NASAL RASP

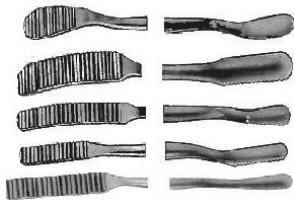

Number	Description	Working Length
R38001	Double ended nasal rasp Serrated Glabella	19 cm
R38002	Double ended nasal rasp Serrated fine wide curved	19 cm
R38003	Double ended nasal rasp Serrated coarse wide straight	19 cm
R38004	Double ended nasal rasp Serrated coarse short	19 cm
R38005	Double ended nasal rasp Serrated coarse wide straight	19 cm

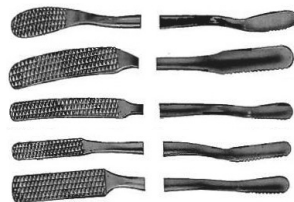

Number	Description	Working Length
R38101	Double ended nasal rasp cross hatched Glabella	19 cm
R38102	Double ended nasal rasp cross hatched fine wide curved	19 cm
R38103	Double ended nasal rasp cross hatched coarse wide straight	19 cm
R38104	Double ended nasal rasp cross hatched coarse short	19 cm
R38105	Double ended nasal rasp cross hatched coarse wide straight	19 cm



FOMON DOUBLE ENDED RASP

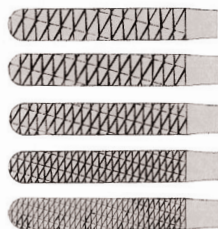

Number	Description	Working Length
R52001	Double ended TC rasp # 1 & 2 xfine - fine	20 cm
R52002	Double ended TC rasp # 3 & 4	20 cm
R52003	Double ended TC rasp # 5 & 6	20 cm
R52004	Double ended TC rasp # 7 & 8	20 cm
R52005	Double ended TC rasp # 9 & 10 coarse - xcoarse	20 cm



COTTLE NASAL TC RASP



Number	Description	Working Length
R39221	TC rasp downcut medium	21 cm

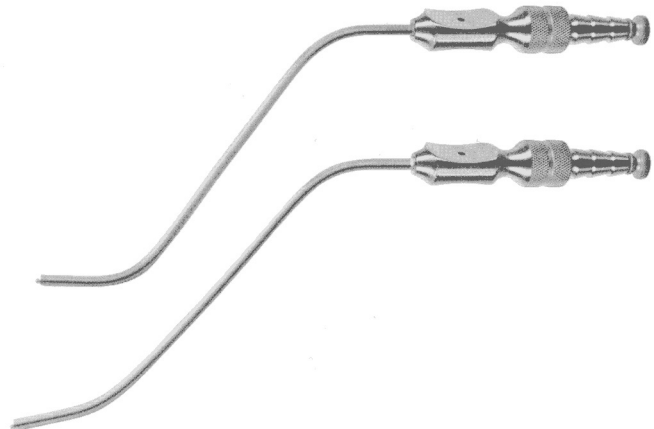

V. EICKEN SINUS ANTRUM CANNULA

Number	Description		Outer diameter	Working Length
S49602	Long curved	LUER-Lock	2.5mm	12 cm
S49603	Long curved	LUER-Lock	3 mm	12 cm
S49604	Long curved	LUER-Lock	4 mm	12 cm
S49612	Short curved	LUER-Lock	2.5 mm	12 cm
S49613	Short curved	LUER-Lock	3 mm	12 cm
S49614	Short curved	LUER-Lock	4 mm	12 cm
S49702	Long curved	Malleable	2.5 mm	12 cm
S49703	Long curved	Malleable	3.0 mm	12 cm
S49704	Long curved	Malleable	4.0 mm	12 cm

KAHN-FRAZIER FRONTAL SINUS SUCTION

Number	Description	Inner ID	Shaft	Size	Working Length
S11610	Frontal Sinus Suction Tube with cut-off hole	10 Fr	malleable	1	slightly curved 15 cm
S11710	Frontal Sinus Suction Tube with cut-off hole	10 Fr	malleable	2	strongly curved 15 cm

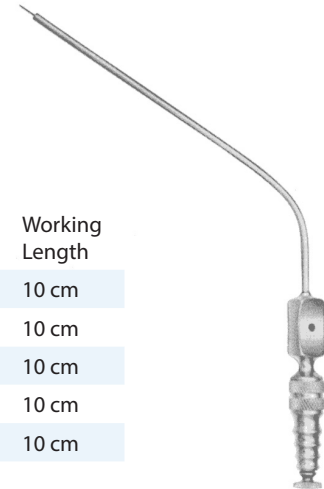
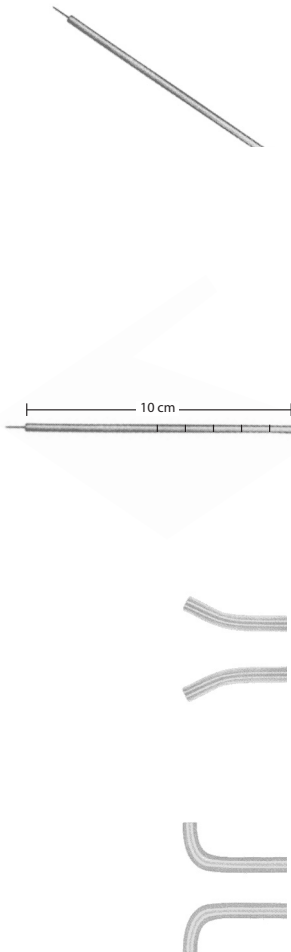
FRAZIER/FERGUSON NASAL STYLE



Number	Description	Material	Fr	Working Length
S43006	Frazier suction tube	Stainless	6 Fr	10 cm
S10008	Frazier suction tube	Stainless	8 Fr	10 cm
S10010	Frazier suction tube	Stainless	10 Fr	10 cm
S10012	Frazier suction tube	Stainless	12 Fr	10 cm
S10015	Frazier suction tube	Stainless	15 Fr	10 cm

Number	Description	Material	Curvature	Fr	Working Length
S11006	FRAZIER Suction Tube with calibrations		marked at 5 cm - 9 cm	6 Fr	10 cm
S11008	FRAZIER Suction Tube with calibrations		marked at 5 cm - 9 cm	8 Fr	10 cm
S11010	FRAZIER Suction Tube with calibrations		marked at 5 cm - 9 cm	10 Fr	10 cm
S11210	Frazier suction tube	stainless	slightly curved right	10 Fr	10 cm
S11212	Frazier suction tube	stainless	slightly curved right	12 Fr	10 cm
S11310	Frazier suction tube	stainless	slightly curved left	10 Fr	10 cm
S11312	Frazier suction tube	stainless	slightly curved left	12 Fr	10 cm
S11410	Frazier suction tube	stainless	strongly curved right	10 Fr	10 cm
S11412	Frazier suction tube	stainless	strongly curved right	12 Fr	10 cm
S11510	Frazier suction tube	stainless	strongly curved left	10 Fr	10 cm
S11512	Frazier suction tube	stainless	strongly curved left	12 Fr	10 cm

FRAZIER/FERGUSON NASAL STYLE WITH BALL END



Number	Description	Material	End Type	Fr	Working Length
S10016	Frazier suction tube	stainless	ball ended	6 Fr	10 cm
S10018	Frazier suction tube	stainless	ball ended	8 Fr	10 cm
S10020	Frazier suction tube	stainless	ball ended	10 Fr	10 cm
S10022	Frazier suction tube	stainless	ball ended	12 Fr	10 cm
S10025	Frazier suction tube	stainless	ball ended	15 Fr	10 cm

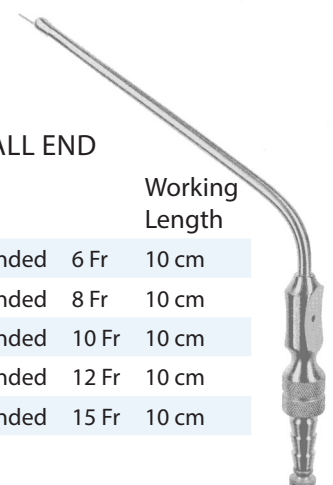

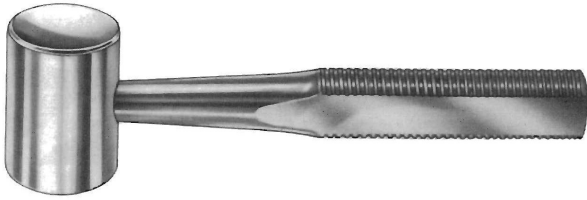

COTTLE MALLET

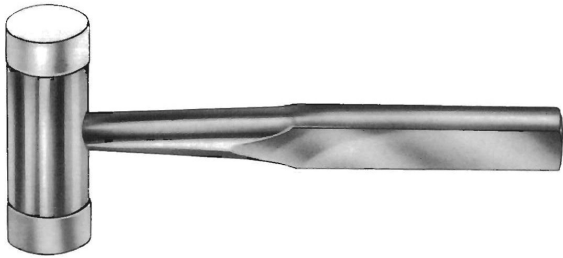
Number	Description	Weight	Working Length
R13000	Mallet	240 g	19 cm

MALLET WITH NYLON CAPS

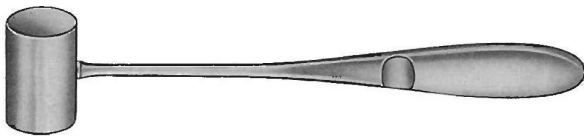
Number	Description	Weight	Working Length
R13500	Mallet with replaceable nylon caps	140 g	18 cm
R13501	Nylon facings for S13500 mallet, 1 pair		

THEISS MINI MALLET

Number	Description	Weight	Working Length
R53516	Mini mallet	140 g	16.5 cm

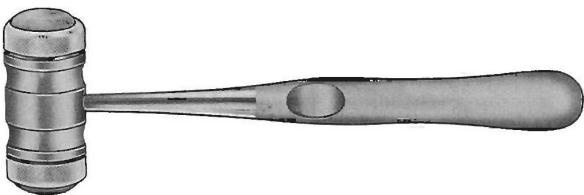
TARDY TYPE MALLET

Number	Description	Weight	Working Length
R528320	Rhinoplasty mallet	320 g	17 cm
R528321	Nylon Facing for Tardy, 1 Pair		

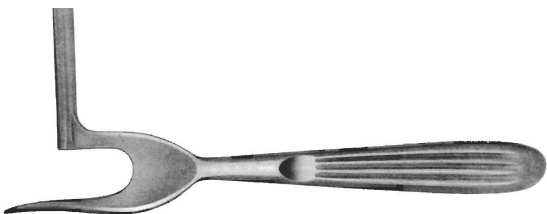
QUISLING INTRANASAL HAMMER

Number	Description
R413900	Quisling Intra-nasal hammer

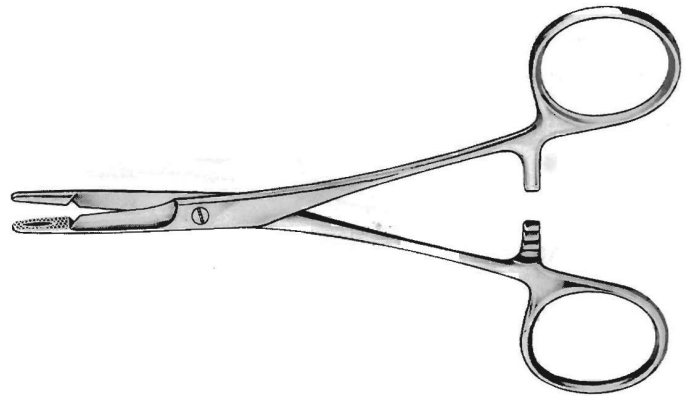

OLSEN-HEGAR NEEDLE HOLDER SCISSORS

Number	Description	Working Length
R14614	Needle holder scissors	14 cm
R14618	Needle holder scissors	17 cm
R15019	Needle holder scissors	19 cm



GILLIES CURVED

Number	Description	Working Length
R15516	Hand grasped needle holder/scissors	16 cm

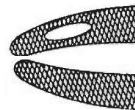

DERF NEEDLE HOLDER

Number	Description	Material	Tip	Working Length
R05012	Needle Holder	stainless	serrated	12 cm
R05012T	Needle Holder	TC	serrated	12 cm



WEBSTER NEEDLE HOLDER

Number	Description			Working Length
R06013	Needle holder	smooth	Stainless	13 cm
R46013	Needle holder	smooth	TC	13 cm

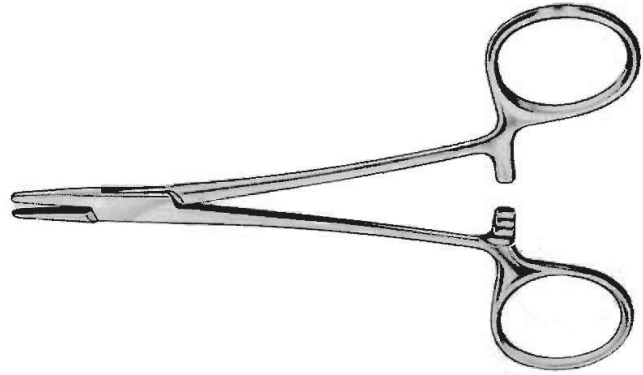

HALSEY NEEDLE HOLDER

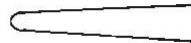
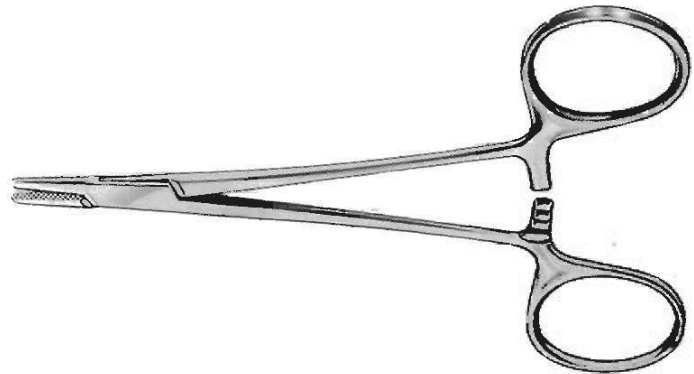
Number	Description			Working Length
R06413	Needle holder	serrated	stainless	13 cm
R46613	Needle holder	serrated	TC	13 cm
R06613	Needle holder	smooth	stainless	13 cm
R46413	Needle holder	smooth	TC	13 cm

CRILE NEEDLE HOLDER

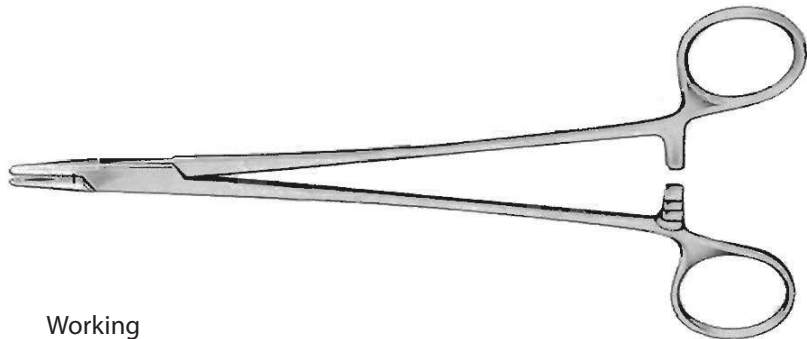
Number	Description			Working Length
R07015	Needle holder	jaw slot	stainless	15 cm
R47015	Needle holder	jaw slot	TC	15 cm
R07215	Baby needle holder	no slot	stainless	15 cm
R46815	Baby needle holder	no slot	TC	15 cm

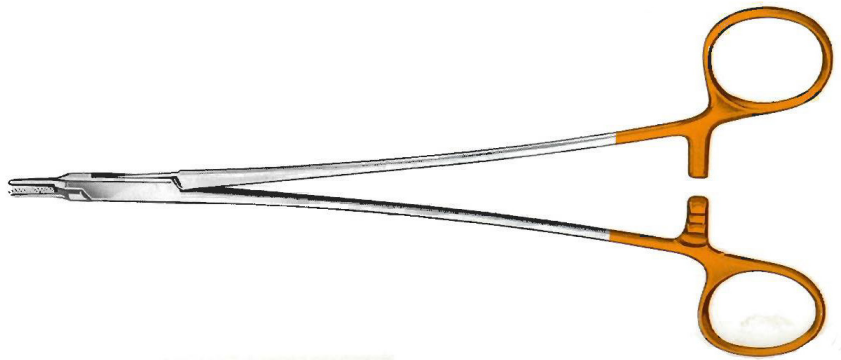



RYDER NEEDLE HOLDER

Number	Description		Working Length
R43413	Fine tipped needle holder	TC	13 cm
R43415	Fine tipped needle holder	TC	15 cm



CASTROVIEJO NEEDLE HOLDER

Number	Description			Working Length
R30452	Needle TC holder	straight	smooth	18 cm
R30453	Needle TC holder	curved	smooth	18 cm
R30450	Needle TC holder	straight	serrated	18 cm
R30451	Needle TC holder	curved	serrated	18 cm

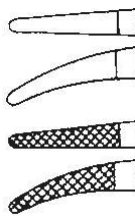
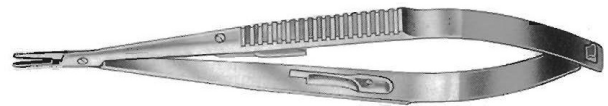

WIRE TWISTERS

Number	Description	Working Length
R0917	MGH Stubby Serrated with Jaw slot	17 cm

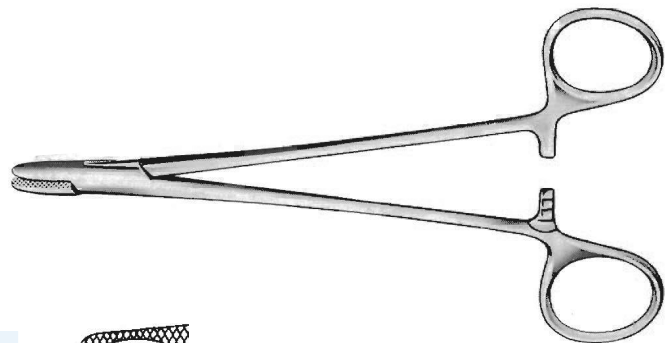

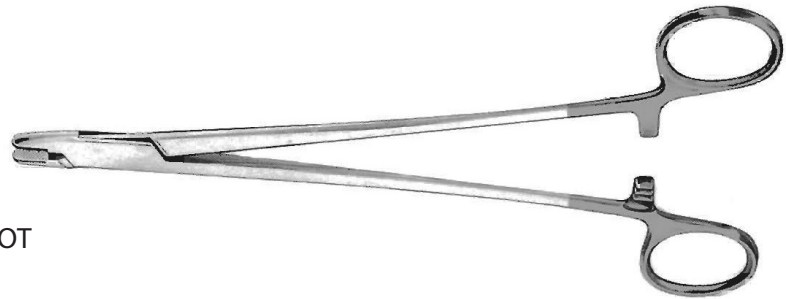

STERUM STUBBY SERRATED WITH JAW SLOT

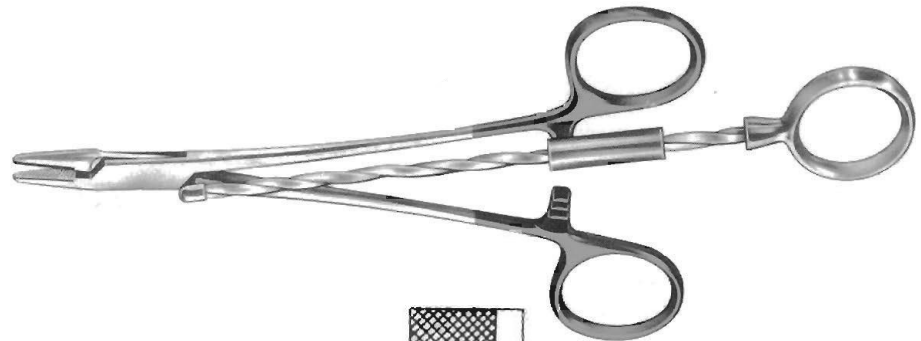
Number	Description	Working Length
R53353416	Sterum Stubby TC	12.5 cm
R53353918	Sterum Stubby TC	18 cm

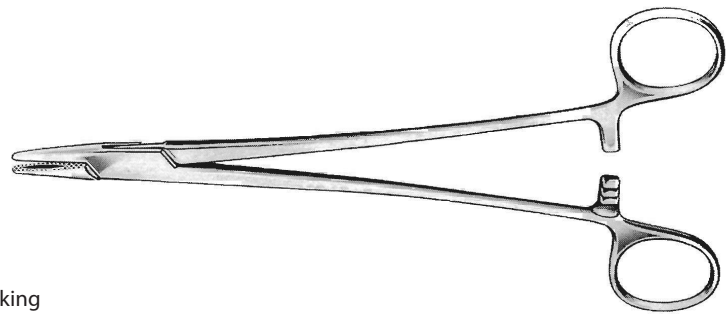
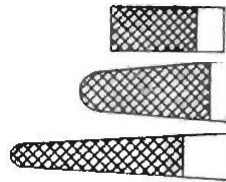

CORWIN FLAT TIP

Number	Description	
R55601	Finger ring wire twister	flat end
R55602	Finger ring wire twister	round end
R55603	Finger ring wire twister	oblong end

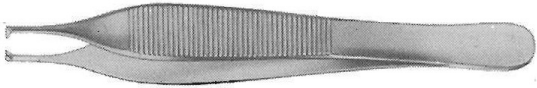

MAYO HEGAR NEEDLE HOLDER

Number	Description		Working Length
S14016	Needle holders	stainless	16 cm
S14018	Needle holders	stainless	18 cm
S14020	Needle holders	stainless	20 cm
R40016	Needle holders with TC Inserts	stainless	16 cm
R40018	Needle holders with TC Inserts	stainless	18 cm
R40020	Needle holders with TC Inserts	stainless	20 cm



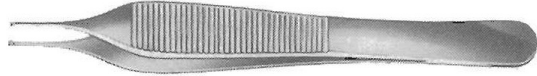

Number	Description	Working Length
R25212	Adson with teeth Standard 1x2	12 cm



Number	Description	Working Length
R110/12	Micro Adson with teeth 1x2	12 cm

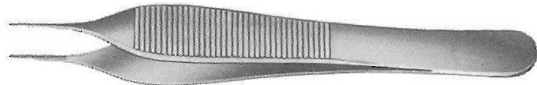

Number	Description	Working Length
R25112	Adson without teeth	12 cm

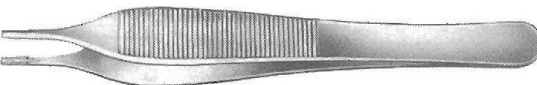

Number	Description	Working Length
R25312	Micro Adson without teeth	12 cm

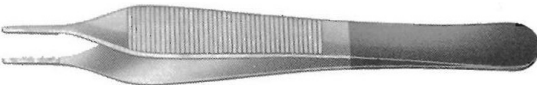

Number	Description	Working Length
R25012	Brown adson	12 cm



Number	Description	Working Length
R25612	Adson pickups TC inserts w/o teeth	12 cm

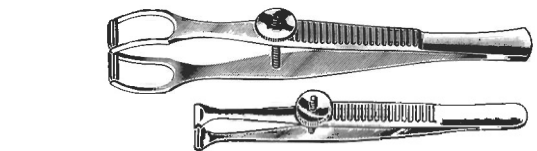

R25712	Adson pickups TC inserts 1x2 teeth	12 cm
--------	------------------------------------	-------

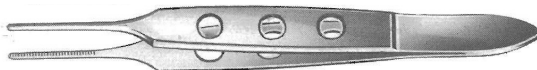

Number	Description	Working Length
R76004	Jewelers forceps straight #4	11 cm
R76005	Jewelers forceps straight #5	11 cm

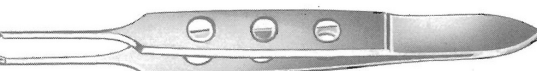

Number	Description	Tip	Working Length
R04701	Castroviejo forceps 1x2 teeth	.12 mm	12 cm



Number	Description	Pattern	Working Length
R01000	Cottle columella forceps	standard	10.5 cm
R01100	Cottle columella forceps	child/small	8.5 cm



Number	Description	Working Length
R04210	Bishop Harmon fine tissue forceps serrated	8.5 cm
R04212	Bishop Harmon fine tissue forceps 1x2 teeth	8.5 cm



R04211	Bishop Harmon delicate fine tissue forceps serrated	8.5 cm
--------	---	--------

R04213	Bishop Harmon delicate fine tissue forceps 1x2 teeth	8.5 cm
--------	--	--------

Number	Description	Working Length
R27015	Cottle fixation forceps with teeth bayonete with fix screw	



UNIVERSAL ATOMIZER KABIERSKE

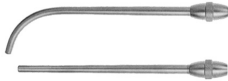

Number	Description
O22810	Universal atomizer Kabierske (S40100)

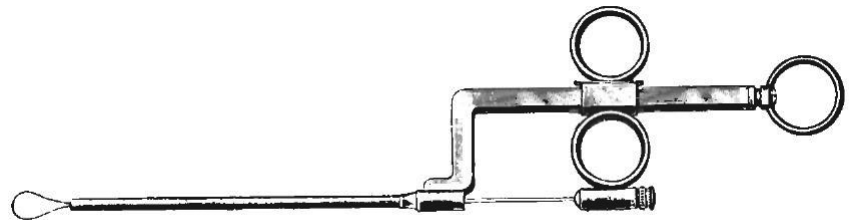

POLYP SNARES AND ACCESSORIES

Number	Description	Working Length
S11500	Wild nasal polyp snare	24 cm

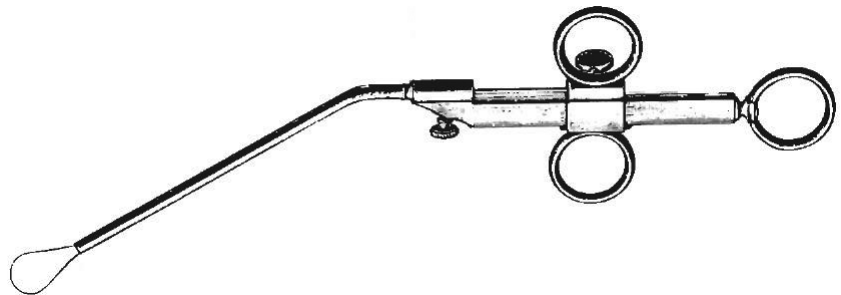

NASAL POLYP SNARE KRAUSE

Number	Description	Working Length
S61520	Nasal polyp snare Krause	26 cm



FRONTAL SINUS RASP

Number	Description	Working Length
S61540	Polyp snare wires precut 12 each	.3 mm
S21042	Polyp snare wire coil	
S21043	Polyp snare wire coil	

K E V U J L U L 4

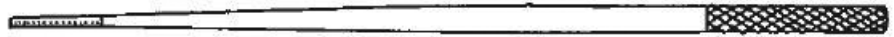

APPLICATORS

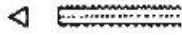

Number	Description			Working Length
S12116	Farrell applicator	triangular	0.9 mm	14 cm
S11513	Farrell applicator	twist tip	1.1 mm	14 cm



GROVED DIRECTOR

Number	Description	Working Length
S91511	Groved director	14 cm



BOWMAN LACRIMAL PROBES SILVER

Number	Description		Working Length
S03400	Bowman silver probes	0000/00	12.5 cm
S03401	Bowman silver probes	00/0	12.5 cm
S03402	Bowman silver probes	0/1	12.5 cm
S03404	Bowman silver probes	1/2	12.5 cm
S03406	Bowman silver probes	2/3	12.5 cm
S03408	Bowman silver probes	3/4	12.5 cm

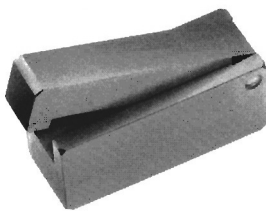

CARTILAGE SMASHER

Number	Description	Working Length
S450000	Cottle cartilage smasher	

SEPTUM TONSIL NEEDLES

Number	Description		Shaft	Tip
S01100	Septum tonsil needle	knee bent angular	LUER-Lock	0.8 mm 22 g
S11400	Septum tonsil needle	straight	LUER-Lock	0.8 mm 22 g
S11300	Septum tonsil needle	right angle tip	LUER-Lock	0.8 mm 22 g
S11700	Septum tonsil needle	bayonet	LUER-Lock	0.8 mm 22 g

SOLUTION BOWLS

Number	Description		
S97030	Stainless solution bowl	30 cc	1 oz
S97050	Stainless solution bowl	50 cc	1.6 oz
S97100	Stainless solution bowl	100 cc	3 oz
S97150	Stainless solution bowl	150 cc	5 oz

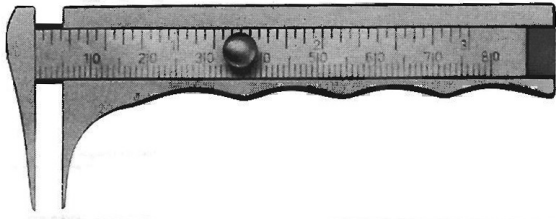

Number	Description	Length
S63100	Jamison Caliper	0-8 mm

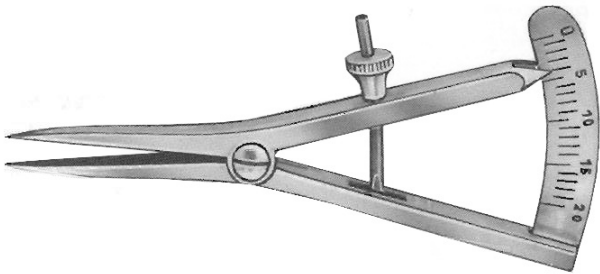

Number	Description	Length
S00040	Castroviejo Caliper	20 mm 8 cm



Number	Description	Material
S43715	Ruler 6"	stainless

PARANASAL SKULL BASE INSTRUMENTS

R&CS ACC

DIS

OTO ACC

OSS

LAR ACC

SPE ACC

RHINS

PSB

OTO INS

LAR INS

ORO/NAS INS

FLEXIBLE TENSION ARM

Number	Description
O18800	Arm for holding nasal speculum and retractors
O18801	Rotation OR table clamp for above

COTTLE MASING NASAL SPECULUM

Number	Description	
S97635	Nasal speculum for use with flexible tension arm	35 mm
S97650	Nasal speculum for use with flexible tension arm	50 mm
S97675	Nasal speculum for use with flexible tension arm	75 mm
S97690	Nasal speculum for use with flexible tension arm	90 mm

AUFRICHT RETRACTOR

Number	Description	
S97300	Retractor for use with flexible tension arm	stainless

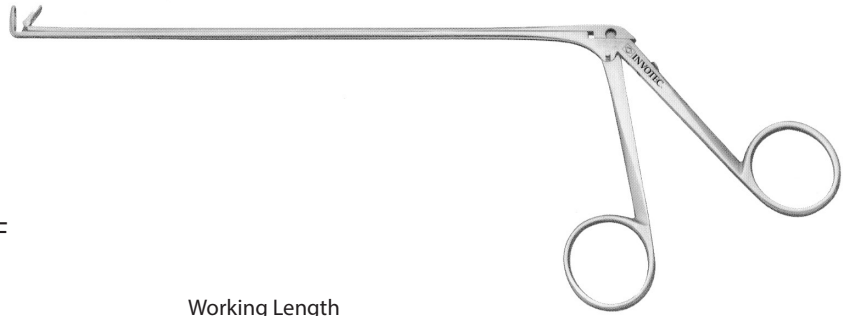

DOUBLE PRONG RETRACTOR

Number	Description	
S97400	Dull double prong retractor for use flexible tension arm	stainless

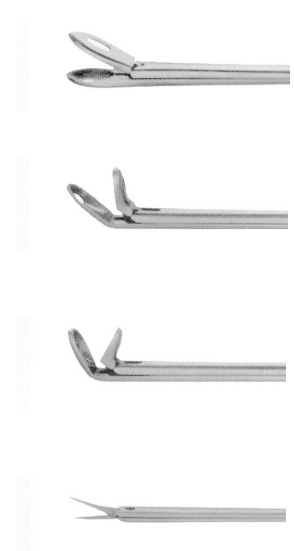

INSTRUMENTS AS DESCRIBED BY DRAF

Number	Description		Working Length
S38413	Ethmoid forceps	straight	13 cm
S38416	Ethmoid forceps	straight	16 cm
S38419	Ethmoid forceps	straight	19 cm
S38513	Ethmoid forceps	60° upcurved	13 cm
S38516	Ethmoid forceps	60° upcurved	16 cm
S38519	Ethmoid forceps	60° upcurved	19 cm
S38613	Ethmoid forceps	90° upcurved	13 cm
S38616	Ethmoid forceps	90° upcurved	16 cm
S38619	Ethmoid forceps	90° upcurved	19 cm
S38713	Ethmoid scissors	straight	13 cm
S38716	Ethmoid scissors	straight	16 cm
S38719	Ethmoid scissors	straight	19 cm



ELONGATED PARANASAL FORCEPS

Number	Description		Jaw	Working Length	
S38901	Conchotome	very delicate	oval throughcutting	3 x 1 mm straight	14 cm

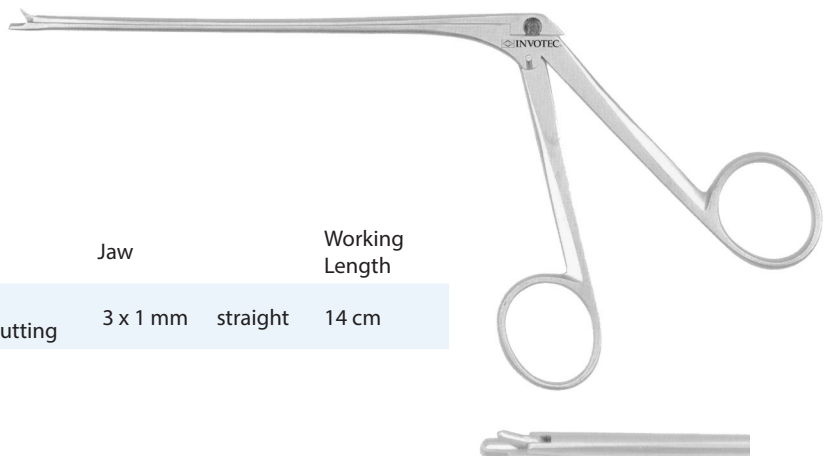

PARANASAL FORCEPS

Number	Description				Working Length
S38423	Ethmoid forceps	straight	oval cupped	3 x 1.5 mm	13 cm
S38426	Ethmoid forceps	straight	oval cupped	3 x 1.5 mm	16 cm
S43010	Ethmoid forceps	straight	delicate serrated		16 cm
S43015	Ethmoid forceps	straight	rough serrated		16 cm

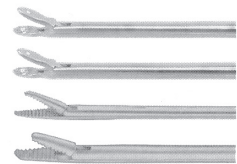
TUBULAR ELONGATED PARANASAL FORCEPS

Number	Description				Working Length
S42100	Ethmoid forceps	"Blakesley Type"	straight	size 0	17 cm
S42101	Ethmoid forceps	"Blakesley Type"	straight	size 1	17 cm
S42102	Ethmoid forceps	"Blakesley Type"	straight	size 2	17 cm
S42200	Ethmoid forceps	"Blakesley Type"	45° upcurved	size 0	17 cm
S42201	Ethmoid forceps	"Blakesley Type"	45° upcurved	size 1	17 cm
S42300	Ethmoid forceps	"Takahashi type"	straight	spoon 3 x 10 mm	17 cm



R&CS ACC

DIS

OTO ACC

OSS

LAR ACC

SPE ACC

RHI INS

PSB

OTO INS

LAR INS

ORO/NAS INS

OTOLOGY

INSTRUMENTS

STEEL TUNING FORKS

Number	Description
O20505	Hartmann tuning fork set with case Set of 5: c ² -512, c ³ -1024, c ⁴ -2048, c-128, c ¹ -256

Number	Description
O20508	Hartmann tuning fork set with case Complete set: O20512-O20561

Number	Description
O20512	Hartmann tuning fork c ² -512
O20513	Hartmann tuning fork c ³ -1024
O20514	Hartmann tuning fork c ⁴ -2048
O20515	Hartmann tuning fork c ⁵ -4096
O20532	French tuning fork c ¹ -32
O20559	Hartmann tuning fork c-64
O20560	Hartmann tuning fork c-128
O20561	Hartmann tuning fork c ¹ -256

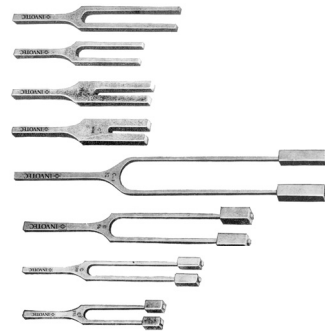

ALUMINUM TUNING FORKS

Number	Description
O20705	Aluminum tuning fork set with case Set of 5: c-128, c ¹ -256, c-512, c ³ -1024, c-2048

Number	Description
O20710	Aluminum tuning fork c-128
O20711	Aluminum tuning fork c ¹ -256
O20712	Aluminum tuning fork c-512
O20713	Aluminum tuning fork c ³ -1024
O20714	Aluminum tuning fork c-2048



NOISE BOX - OTOSCOPE

Number	Description
O20950	Barany Noise Apparatus with hard rubber connector Black Rack included

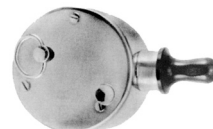
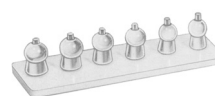

Number	Description
O20010	Brunings Pneumatic Ear Speculum Complete Set with lens, 4 speculas, rubber bulb, and wooden case



Number	Description	Diameter
O20020	Brunings Ear Speculum Size 0	5.5 mm
O20021	Brunings Ear Speculum Size 1	6.5 mm
O20022	Brunings Ear Speculum Size 2	7.5 mm
O20023	Brunings Ear Speculum Size 3	8.5 mm
O20024	Brunings Ear Speculum Size 4	9.5 mm
O20025	Brunings Ear Speculum Size 5	10.5 mm



Number	Description
O20013	Brunings Diagnostic Head Full lens



Number	Description
O20014	Brunings Operating Head Segmented lens
O20015	Rubber Bulb Fitting the Brunings and Siegle lenses

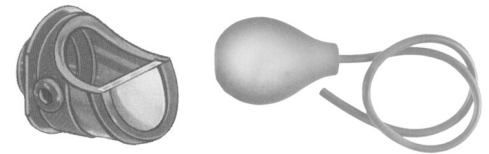

Number	Description	Diameter
O20053	Siegle Pneumatic Ear Speculum lens	
O20061	Siegle Ear Speculum	6.0 mm
O20062	Siegle Ear Speculum	6.5 mm
O20063	Siegle Ear Speculum	7.5 mm

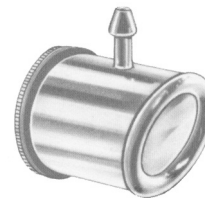

Number	Description	Diameter
O20161	Boucheron Ear Speculum for Adults	Set of 4
O20166	Boucheron Ear speculum for adults	4.5 mm
O20167	Boucheron Ear speculum for adults	5.5 mm
O20168	Boucheron Ear speculum for adults	6.5 mm
O20169	Boucheron Ear speculum for adults	4.5 mm



Number	Description	Diameter
O20100	Hartmann Ear Speculum for children Set of 3	3.0, 4.5, 5 mm
O20101	Hartmann Ear Speculum for children	3.0 mm
O20102	Hartmann Ear Speculum for children	4.5 mm
O20103	Hartmann Ear Speculum for children	5 mm

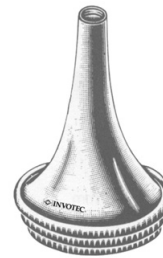

Number	Description	Diameter
O20110	Hartmann Ear Speculum for adults Set of 3	5.5, 6.5, 7.5 mm
O20111	Hartmann Ear Speculum for adults	5.5 mm
O20112	Hartmann Ear Speculum for adults	6.5 mm
O20113	Hartmann Ear Speculum for adults	7.5 mm

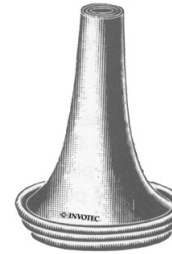

Number	Description	Diameter
O20130	Toynbee Ear Speculum for adults Set of 3	5.5, 6.5, 7.5 mm
O20131	Toynbee Ear Speculum for adults Set of 4	4.5, 5.5, 6.5, 7.5mm
O20136	Toynbee Ear Speculum for adults	4.5 mm
O20137	Toynbee Ear Speculum for adults	5.5 mm
O20138	Toynbee Ear Speculum for adults	6.5 mm
O20139	Toynbee Ear Speculum for adults	7.5 mm



Number	Description	Diameter
O20190	Ear Speculum Set of 6	
O20192	Ear Speculum	2 mm
O20193	Ear Speculum	3 mm
O20194	Ear Speculum	4 mm
O20195	Ear Speculum	5 mm
O20196	Ear Speculum	6 mm
O20197	Ear Speculum	7.5 mm



Number	Description	Diameter
O20300	Zoellner Operating Ear Speculum Black-finish Oval Set of 6	
O20311	Zoellner Operating Ear Speculum Black-finish Oval	5.5 x 6.5 mm
O20312	Zoellner Operating Ear Speculum Black-finish Oval	6.5 x 7.5 mm
O20313	Zoellner Operating Ear Speculum Black-finish Oval	7.5 x 8.5 mm
O20314	Zoellner Operating Ear Speculum Black-finish Oval	8.5 x 9.5 mm
O20315	Zoellner Operating Ear Speculum Black-finish Oval	9.5 x 10.5 mm
O20316	Zoellner Operating Ear Speculum Black-finish Oval	10.5 x 11.5 mm





Number	Description		length	Size	Diameter
O21251	Buck-Wullstein micro ear currettes	blunt	16 cm	000	1.1 mm
O21252	Buck-Wullstein micro ear currettes	blunt	16 cm	00	1.3 mm
O21253	Buck-Wullstein micro ear currettes	blunt	16 cm	0	1.8 mm
O21254	Buck-Wullstein micro ear currettes	blunt	16 cm	1	2.1 mm



Number	Description		length	Size	Diameter
O21431	Shapleigh ear currettes	serrated	14 cm	1	
O21432	Shapleigh ear currettes	serrated	14 cm	2	

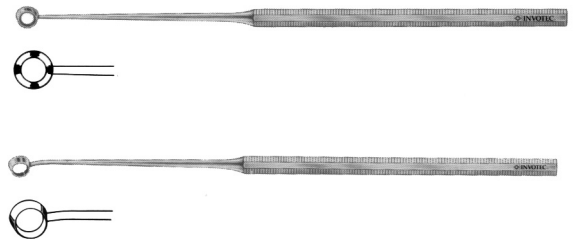

Number	Description		length	Size	Diame...
O21109	Buck ear currettes	sharp	15 cm	00	1.5 mm
O21110	Buck ear currettes	sharp	15 cm	0	1.9 mm
O21111	Buck ear currettes	sharp	15 cm	1	2.5 mm
O21112	Buck ear currettes	sharp	15 cm	2	2.7 mm
O21113	Buck ear currettes	sharp	15 cm	3	3.4 mm
O21114	Buck ear currettes	sharp	15 cm	4	4.0 mm
O21115	Buck ear currettes	sharp	15 cm	5	4.5 mm

EAR LOOPS



Number	Description		length	Size	Diameter
O21401	Billeau ear loop	straight	15.5 cm	1	
O21402	Billeau ear loop	straight	15.5 cm	2	
O21403	Billeau ear loop	straight	15.5 cm	3	

Number	Description		length	Diameter
O21410	Langenbeck ear loop	blunt	13.5 cm	



EAR LEVERS

Number	Description	length
O21440	Moldenhauer ear lever	16 cm



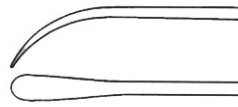

Number	Description	length
O21505	Zaufal ear lever	16 cm



Number	Description	Length
O21510	Yankauer-Jansen ear lever 45°	15 cm



Number	Description	Length
O21606	Wagener ear lever sharp	14 cm
O21607	Wagener ear lever blunt	14 cm

EAR HOOKS



Number	Description	Size	length
O21470	Gross ear spoon and hook	oval	12 cm



Number	Description	Size	length
O21475	Gross ear curette and hook	round	12 cm



Number	Description	Size	length
O21511	Jansen ear hook	1	15 cm
O21512	Jansen	2	15 cm



Number	Description	Size	length
O21520	Allport ear hook		16 cm



Number	Description	Size	length
O21571	Hartmann ear hook	1	16 cm
O21572	Hartmann ear hook	2	16 cm



Number	Description	Size	length
O21601	Wagener ear hook	2.0	14 cm
O21602	Wagener ear hook	2.5	14 cm
O21603	Wagener ear hook	3.0	14 cm
O21604	Wagener ear hook	3.5	14 cm
O21605	Wagener ear hook	4.0	14 cm



Number	Description	Size	length
O21651	Day ear hook	1	16 cm
O21652	Day ear hook	2	16 cm



Ear Probes

Number	Description		length
O21681	Stacke ear probe	Nickel silver	11 cm
O21684	Stacke-Frenzel ear probe	Sterling silver	9 cm

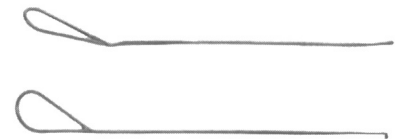

Number	Description		length
O21690	Wullstein probe	Silver	26 cm
O21695	Bloch ear probe	Sterling silver	11 cm



SICKLE SHAPED KNIVES AND LANCETS

Number	Description	length
O21750	Lempert sickle shaped knife	16 cm
O21752	Lempert sickle shaped knife	17 cm
O21760	Politzer sickle shaped knife	16 cm
O21802	Buck lancet	15 cm
O21806	Lempert lancet	14 cm
O21810	Lempert lancet	15 cm
O21811	Lempert lance	45° 15 cm

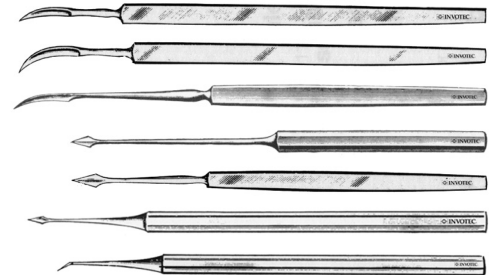
TYMPANUM PERFORATORS

Number	Description	Length
O21823	Politzer Tympanum perforator	16 cm

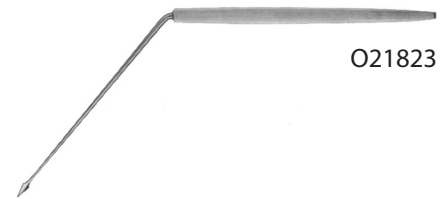
O21823

O21825	Lucae Tympanum perforator	for children	18 cm
O21827	Lucae Tympanum perforator	for adults	18 cm

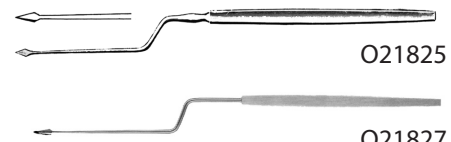
O21825
O21827

O21830	Politzer Tympanum perforator	reversible	19 cm
O21833	Politzer Tympanum perforator	screw locking handle	15 cm

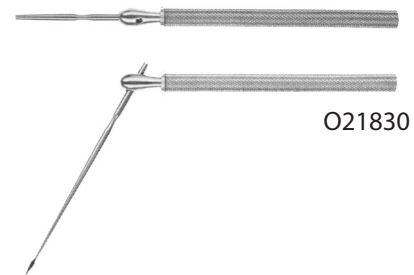
O21830
O21833

O21835	Lucae Tympanum perforator		19 cm
--------	---------------------------	--	-------

O21835

O21845	Sexton Tympanum knife		18 cm
O21847	Sexton Tympanum knife		18 cm
O21850	Sexton Tympanum knife		18 cm
O21853	Sexton Tympanum knife		18 cm
O21857	Sexton Tympanum knife		18 cm

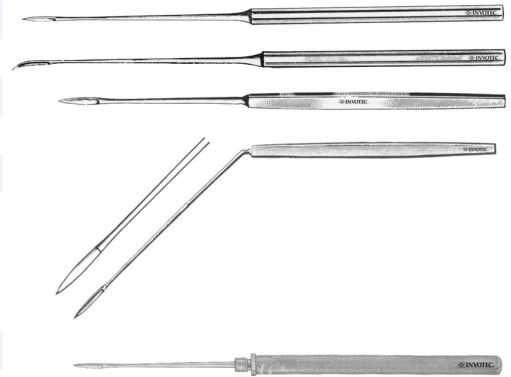

O21858	Sexton Tympanum knife	screw locking handle	18 cm
--------	-----------------------	----------------------	-------

EAR CATHETERS

Number	Description	Length	size	Diameter
O22011	Hartmann ear catheter	14 cm	1	2.5 mm
O22012	Hartmann ear catheter	14 cm	2	3.0 mm
O22013	Hartmann ear catheter	14 cm	3	3.5 mm
O22014	Hartmann ear catheter	14 cm	4	4.0 mm
O22015	Hartmann ear catheter	14 cm	5	5.0 mm



O22021	Troeltsch Ear catheter	14 cm	1	2.5 mm
O22022	Troeltsch Ear catheter	14 cm	2	3.0 mm
O22023	Troeltsch Ear catheter	14 cm	3	3.5 mm
O22024	Troeltsch Ear catheter	14 cm	4	4.0 mm
O22025	Troeltsch Ear catheter	14 cm	5	5.0 mm



O22030	Tube connector for Hartmann/Troeltsch catheters		Olive-shaped	
--------	---	--	--------------	--



AIR BAGS

Number	Description	Diameter
O22055	Politzer air bag with conical metal plate - rubber bulb only	
O22062	Politzer air bag nasal tip	15 mm
O22063	Politzer air bag nasal tip	17 mm
O22064	Politzer air bag nasal tip	22 mm
O22069	Politzer air bag connector with plugin cone and screw thread	

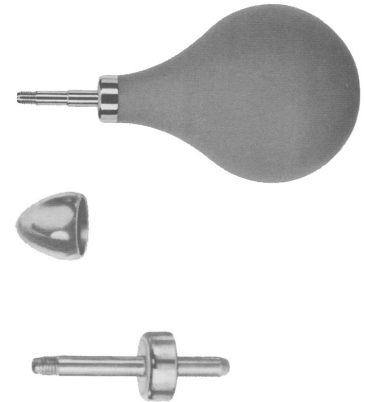

POWDER BLOWER

Number	Description		
O22810	Kabierske powder blower complete set: 3 cannulas for ear, nose, throat and larynx		
O22811	Kabierske spare glass bottle	30 ml	
O22812	Kabierske valve rubber bulb		
O22816	Kabierske laryngeal cannula	curved	13 cm x 5 1/8"
O22817	Kabierske nasal cannula	straight	11 cm x 4 3/8"
O22818	Kabierske ear cannula	straight	8 cm x 3 1/8"



EAR INSTRUMENT SETS

Number	Description	
O21901	Sprague ear instrument	sickle-shaped knife 
O21902	Sprague ear instrument	blunt-tip hook 
O21903	Sprague ear instrument	button-tip probe 
O21904	Sprague ear instrument	tympanum perforating lancet 
O21905	Sprague ear instrument	ear curette 
O21906	Sprague ear instrument	ear spoon 
O21909	Sprague ear instrument	tubular handle 

Number	Description		Diameter
O22101	Rosen suction tip with Luer-Lock attachment	Straight	0.70 x 80 mm
O22102	Rosen suction tip with Luer-Lock attachment	Straight	0.90 x 80 mm
O22103	Rosen suction tip with Luer-Lock attachment	Straight	1.20 x 80 mm



O22111	Rosen suction tip with Luer-Lock attachment	angled	0.70 x 65 mm
O22112	Rosen suction tip with Luer-Lock attachment	angled	0.90 x 65 mm
O22113	Rosen suction tip with Luer-Lock attachment	angled	1.20 x 65 mm
O22114	Rosen suction tip with Luer-Lock attachment	angled	1.50 x 65 mm
O22115	Rosen suction tip with Luer-Lock attachment	angled	2.00 x 65 mm



Number	Description	Diameter
O22210	Baron suction tip with finger cut off	1.0 x 75 mm
O22215	Baron suction tip with finger cut off	1.5 x 75 mm
O22220	Baron suction tip with finger cut off	2.0 x 75 mm

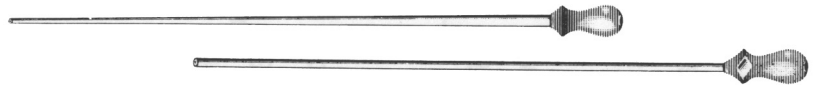
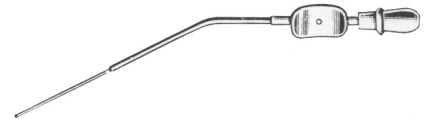

Number	Description			Length	Diameter
O22141	Wullstein flexible suction tip with Luer Cone	cylindrical	Sterling Silver	16 cm	1.5 mm
O22142	Wullstein flexible suction tip with Luer Cone	cylindrical	Sterling Silver	16 cm	2.0 mm
O22148	Wullstein flexible suction tip with Luer Cone	conical	Sterling Silver	16 cm	1.5 mm

Number	Description	
O22148	Tube connector with Luer cone and cut off plate	for Wellstein and Rosen suction tubes



Number	Description
O22146	Wullstein irrigating suction handle with Luer cone Compatible with Wullstein irrigating/suction tubes



Number	Description	Working Length	Diameter
O22230	Zollner suction tube with finger plate and Luer cone Complete with 1 slip on cannula		0.7 mm
O22235	Zollner micro suction cannula only for suction tube	30 mm	0.5 mm
O22237	Zollner micro suction cannula only for suction tube	30 mm	0.7 mm

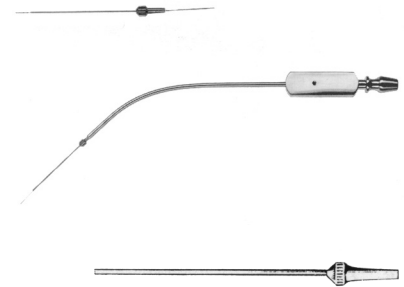

Number	Description	Working Length	Diameter
O22261	Frazier suction tube	110 mm	1.00 mm x 190 mm
O22262	Frazier suction tube	110 mm	2.00 mm x 190 mm

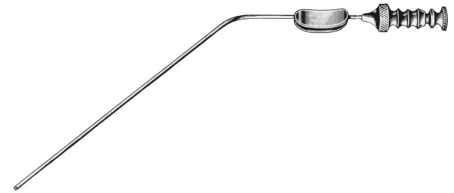

Number	Description	
O22271	Hartmann suction tip	right ear
O22272	Hartmann suction tip	left ear



Number	Description	Size	diameter
O22309	House suction tip	1	0.9 + 0.7 mm
O22312	House suction tip	2	1.2 + 0.9 mm
O22315	House suction tip	3	1.5 + 1.2 mm
O22318	House suction tip	1	1.8 + 1.8 mm
O22325	House suction tip	2	2.5 + 2.0 mm
O22330	House suction tip	3	3.0 + 2.0 mm
O22345	House suction tip	4	4.5 + 2.0 mm

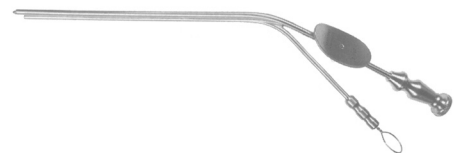

PERIOSTEOTOMES, ELEVATOR



Number	Description	
O26010	Muck periosteal knife	13 cm



Number	Description	
O26020	Poltzer mastoid knife	13 cm

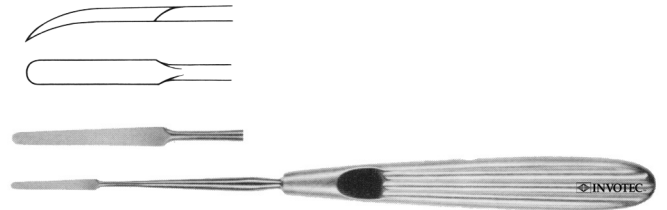

Number	Description	size	shape	length
O26052	Lempert elevator	size 2 mm	straight	18 cm
O26057	Lempert elevator	size 2 mm	curved	18 cm
O26058	Lempert elevator	size 3 mm	curved	18 cm

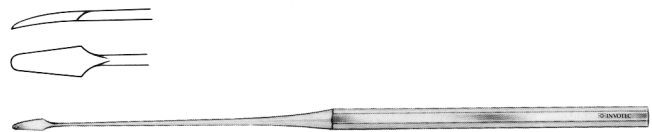

Number	Description	width	length
O26040	Wullstein raspatory		17 cm

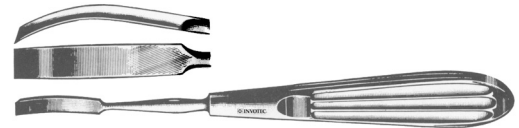

Number	Description	width	length
O26070	Lempert raspatory	6 mm	20 cm
O26071	Lempert raspatory	6 mm	18 cm

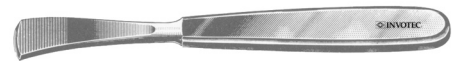

Number	Description	width	length
O26080	Jansen raspatory	12 mm	17 cm

EAR POLYPUS SNARES

Number	Description	Size
O21010	Krause Ear Polypus Snare	16 cm



Number	Description	Size
O21030	Wilde Ear Polypus Snare	16 cm



Number	Description		Size
O21042	Snare-Wire, coil	10 meters	0.2 mm Ø
O21043	Snare-Wire, coil	10 meters	0.3 mm Ø



Number	Description		Size
O21047	Snare-Loops, pre-shaped	bundle/ 100 pieces	0.2mm Ø
O21048	Snare-Loops, pre-shaped	bundle/ 100 pieces	0.3 mm Ø
O21049	Snare-Loops, pre-shaped	bundle/ 100 pieces	0.35 mm Ø



MASTOID RONGEURS

Number	Description		
O26203	Kerrison Rongeur chisel-edge punch	0	80 mm
O26204	Kerrison Rongeur chisel-edge punch	1	80 mm
O26205	Kerrison Rongeur chisel-edge punch	2	80 mm
O26206	Kerrison Rongeur chisel-edge punch	3	80 mm



Number	Description		
O26251	Citelli Rongeur atticus punch	1	60 mm
O26252	Citelli Rongeur atticus punch	2	60 mm
O26253	Citelli Rongeur atticus punch	3	60 mm



Number	Description		
O26265	Brunings rongeur, chisel edged punch		4 mm
O26266	Brunings rongeur, chisel edged punch		6 mm



Number	Description		
O26272	Beyer rongeur atticus punch		2 mm



PUNCHES, MALLEUS NIPPERS

Number	Description	Width
O24805	Davol forceps	3 x 2 mm



Number	Description	Width
O24814	Dieter malleus punch	chisel-edge up cutting 1.3 mm
O24815	Dieter malleus punch	chisel-edge down cutting 1.3 mm
O24816	Dieter malleus punch	chisel-edge right cutting 1.3 mm
O24817	Dieter malleus punch	chisel-edge left cutting 1.3 mm



Number	Description	Width
O23020	Hartmann ear dressing forceps	delicate pattern 13.5 cm
O23021	Hartmann ear dressing forceps	standard pattern 13.5 cm



Number	Description	Width
O23040	Tilly ear dressing forceps	standard pattern 14 cm

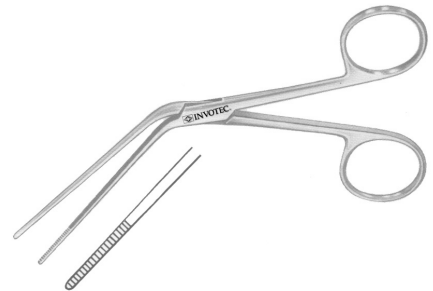

Number	Description	Width
O23112	Hartmann ear forceps	14 cm
O23122	Hartmann ear forceps	20 cm
O23132	Hartmann ear forceps	22 cm



Number	Description	length
O23142	Hartmann-Noyes ear forceps	14 cm
O23152	Hartmann-Noyes ear forceps duckbill	14 cm
O23163	Hartmann ear forceps 1 x 2 teeth	14 cm
O23170	Weingartner ear forceps	14 cm
O23201	Hartmann-Herzfeld ear forceps	14 cm 2 mm
O23202	Hartmann-Herzfeld ear forceps	14 cm 2.2 mm
O23203	Hartmann-Herzfeld ear forceps	14 cm 2.5 mm
O23204	Hartmann-Herzfeld ear forceps	14 cm 3.0 mm
O23211	Hartmann-Herzfeld ear forceps	14 cm 2.0 mm
O23212	Hartmann-Herzfeld ear forceps	14 cm 2.2 mm
O23213	Hartmann-Herzfeld ear forceps	14 cm 2.5 mm
O23214	Hartmann-Herzfeld ear forceps	14 cm 3.0 mm



Number	Description	Length
O23250	Hartmann ear forceps	14 cm
O23260	Struempel ear forceps	14 cm
O23261	Struempel-baby ear forceps	14 cm
O23270	Hartmann ear forceps	2.0 mm





Number	Description	Length
O23301	Hartmann ear forceps smooth jaws	14 cm
O23303	Hartmann ear forceps smooth jaws 1 x 2 teeth	14 cm
O23312	Hartmann ear forceps serrated jaws	14 cm
O23314	Hartmann ear forceps serrated jaws angled up	14 cm



O23322	Bellucci grasping forceps* heavy pattern
--------	--

* may also be used as prosthesis applying or wire bending forceps



Number	Description	Length
O23401	Ear forceps smooth jaws	4 x 0.5 mm
O23412	Ear forceps serrated jaws	4 x 0.5 mm
O23414	Ear forceps serrated jaws angled up	3 x 0.5 mm
O23416	Ear forceps serrated jaws right	3 x 0.5 mm
O23417	Ear forceps serrated jaws left	3 x 0.5 mm
O23422	Ear forceps serrated jaws long	7 x 0.5 mm

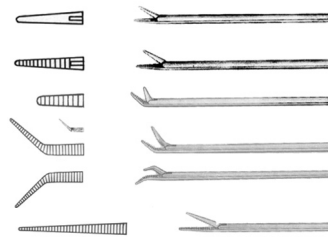

Number	Description	Length
O23512	Ear forceps serrated jaws straight	4 x 0.4 mm
O23514	Ear forceps serrated jaws angled up	4 x 0.4 mm
O23712	Ear forceps delicate with oval cup jaws straight	1 x 0.9 mm
O23714	Ear forceps delicate with oval cup jaws angled up	1 x 0.9 mm
O23716	Ear forceps delicate with oval cut jaws angled right	1 x 0.9 mm
O23717	Ear forceps delicate with oval cut jaws angled left	1 x 0.9 mm

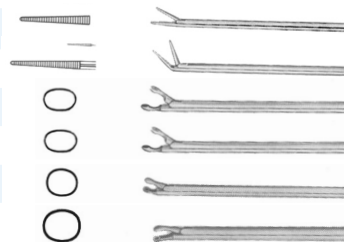



Number	Description			
O23912	Ear forceps	oval cup jaws	straight	0.6 x 0.5 mm
O23914	Ear forceps	oval cup jaws	up	0.6 x 0.5 mm
O23916	Ear forceps	oval cup jaws	right	0.6 x 0.5 mm
O23917	Ear forceps	oval cup jaws	left	0.6 x 0.5 mm

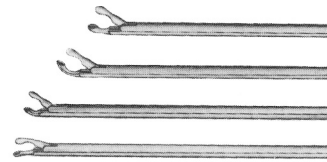

Number	Description		diameter	
O25012	Ear forceps	serrated jaws	straight	5 x 0.5 mm
O25014	Ear forceps	serrated jaws	up	4 x 0.5 mm
O25023	Ear forceps	serrated jaws	long	7 x 0.5 mm
O25030	Ear forceps	with round cup jaws	0.9 mm	
O25035	Ear forceps	with oval cut jaws	1.2 x 0.9 mm	

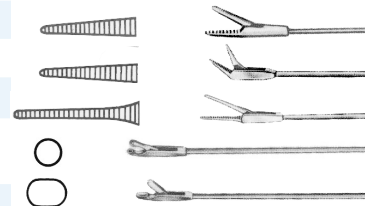

O25060	Wullstein-Blakesley Ear forceps	jaws fenestrated	5 x 2 mm	
--------	---------------------------------	------------------	----------	--



WIRE BENDING FORCEPS

Number	Description		
O24611	Schuknecht Wire crimper	curved down	6.0 x 0.8 mm



Number	Description		
O24614	McGee wire bending forceps	curved down	3.5 x 0.8 mm
O24615	McGee wire bending forceps	curved down	4.5 x 0.8 mm

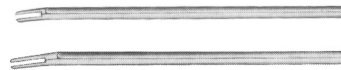
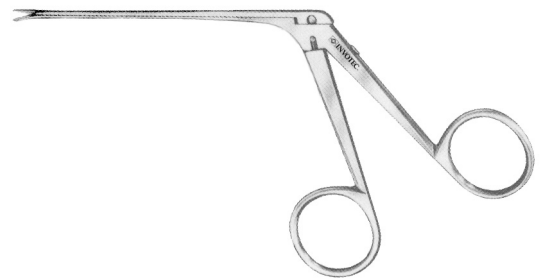

FORCEP PROTECTOR

• autoclavable

Number	Description	Length
O24990	Teflon forcep protector	80 mm



Number	Description	Shaft Width	Shaft Length
O24812	Tabb crura nipper	1.5 mm	65 mm

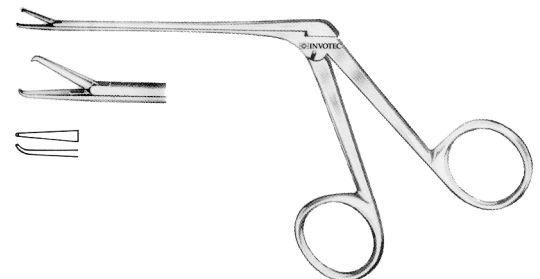



Number	Description	Shaft Length
O24910	Graven grasping forceps serrated jaws 3 x 1 mm	70 mm



Number	Description	Shaft Length
O24919	Fuller forceps smooth jaws 6 x 0.8 mm	75 mm

Number	Description		
O24110	Shea-Bellucci Ear scissors	blunt tip blades	straight
O24112	Shea-Bellucci Ear scissors	straight tip blades	straight
O24116	Shea-Bellucci Ear scissors	semi-sharp tip	curved right
O24117	Shea-Bellucci Ear scissors	semi-sharp tip	curved left



Number	Description		
O24211	Bellucci ear scissors	sharp/blunt tip	straight
O24212	Bellucci ear scissors	sharp tip blades	straight
O24213	Bellucci ear scissors	sharp tip	angled up
O24216	Bellucci ear scissors	sharp tip	curved right
O24217	Bellucci ear scissors	sharp tip	curved left

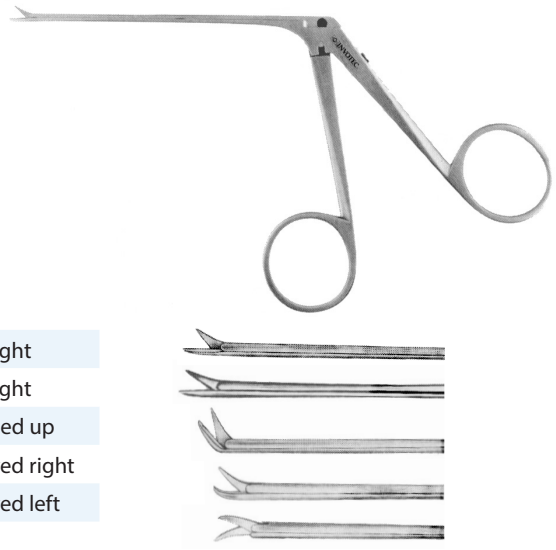

Number	Description		
O25052	Ear scissors	sharp tip blades	straight
O25054	Ear scissors	sharp tip	angled up
O25056	Ear scissors	sharp tip	curved right
O25057	Ear scissors	sharp tip	curved left

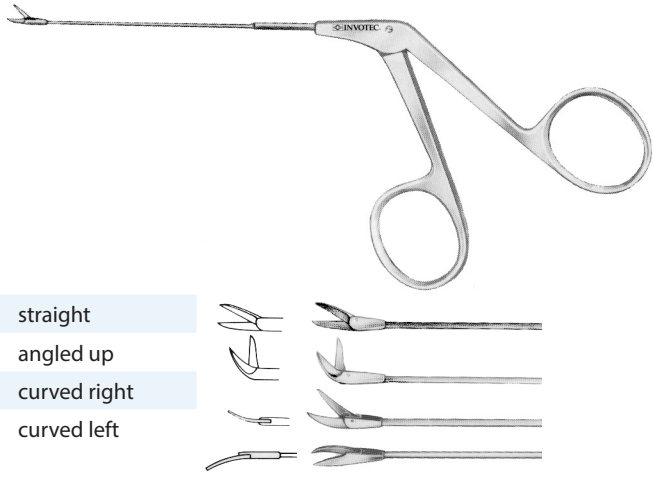



Number	Description	Shaft Length	Length
O24810	Lempert Malleus forceps		11.5 cm



Number	Description	Shaft Length	Length
O24835	Wullstein malleus nipper chisel edge 3 mm long	80 mm	15 cm

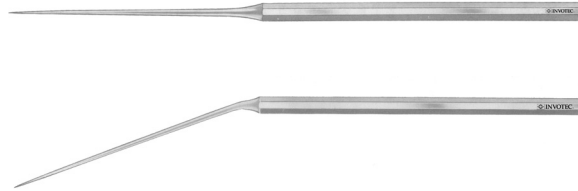

Number	Description
O30601	Barbara sharp needle/pick
O30603	Barbara sharp needle/pick
O30604	Rosen sharp needle/pick
O30605	Rosen blunt needle/pick
O30606	Rosen blunt needle/pick

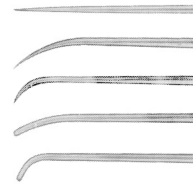

Number	Description				
O30607	Austin hook			1.5 mm	90°
O30613	Austin hook			0.3 mm	25°
O30616	Austin hook			0.6 mm	25°
O30620	Austin hook			1.0 mm	25°
O30641	Austin hook			1.5 mm	45°
O30643	Austin hook			2.5 mm	45°
O30645	Shea hook	oblique pick	blunt	2.0 mm	45°
O30649	Austin hook	attic dissector	blunt	3.0 mm	90°
O30641	Austin hook			1.5 mm	45°
O30643	Austin hook			2.5 mm	45°
O30645	Shea hook	oblique pick	blunt	2.0 mm	45°
O30649	Austin hook	attic dissector	blunt	3.0 mm	90°



Number	Description				
O30772	Antoli-Candela hook	angled right		0.6 mm	90°
O30773	Antoli-Candela hook	angled left		0.6 mm	90°
O30792	Antoli-Candela hook	right		1.0 mm	90°
O30793	Antoli-Candela hook	left		1.0 mm	90°

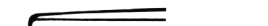



Number	Description		
O30775	McGee hook	curved up	0.5 mm
O30780	McGee hook	curved up	1.0 mm
O30785	McGee hook	curved down	0.5 mm
O30790	McGee hook	curved down	1.0 mm

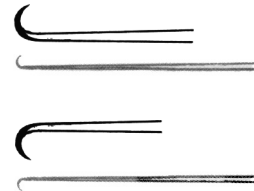

Number	Description		
O30802	Fisch hook		0.2 mm
O30806	Plester hook		0.6 mm

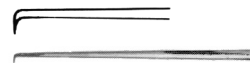



Number	Description	Diameter	Diameter
O30810	Antoli-Candela incision knife	1.0 mm	45°
O30815	Antoli-Candela incision knife	1.5 mm	45°
O30820	Antoli-Candela incision knife	2.0 mm	45°
O30823	Antoli-Candela incision knife	2.3 mm	45°
O30825	Antoli-Candela incision knife	2.5 mm	45°
O30830	Antoli-Candela circular cutting knife	1.0 mm	90°
O30835	Antoli-Candela circular cutting knife	1.5 mm	90°
O30840	Antoli-Candela circular cutting knife	2.0 mm	90°
O30843	Antoli-Candela circular cutting knife	2.3 mm	90°
O30845	Antoli-Candela circular cutting knife	2.5 mm	90°

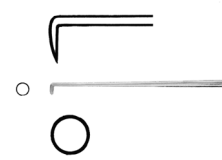
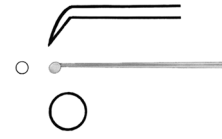

O30901	House round knife for incudo-stapedial joint	1.0 mm	30°
O30903	Goldmann knife-elevator for metal wall	3.0 mm	45°

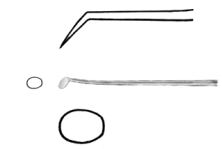
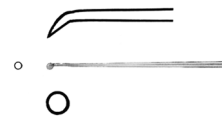

Number	Description	Size
O30906	Rosen knife curette	1.5 mm 45°

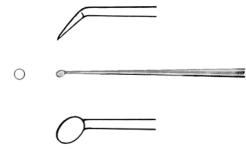

Number	Description	Size
O30911	Antoli-Candela Round knife for incudo-stapedial joint	1.0 mm 45°

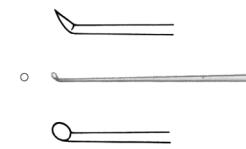

Number	Description	Size
O30922	Austin round knife weapon	2.0 mm 90°

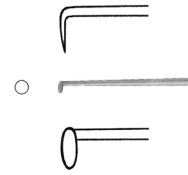

Number	Description	Size
O30925	Gerlach round knife	3.0 mm 90°

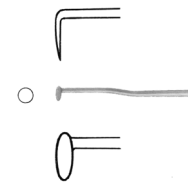

Number	Description	Size
O30935	Shea tympanoplasty knife	1.5 x 1 mm 45°

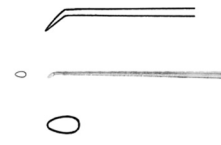

O30938	Shea tympanoplasty knife	4.0 x 2.5 mm 60°
--------	--------------------------	------------------

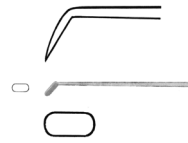

O30939	Harrison tympanoplasty knife	45°
--------	------------------------------	-----

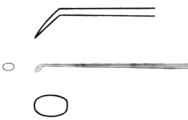

O30947	Harrison tympanoplasty knife	90°
--------	------------------------------	-----

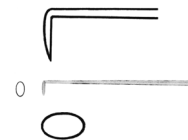



Number	Description	Size
O31061	House tympanoplasty knife	4.0 x 1.0 mm
O31063	House tympanoplasty knife	3.0 x 1.0 mm
O31075	Gray tympanoplasty knife	3.5 mm Ø

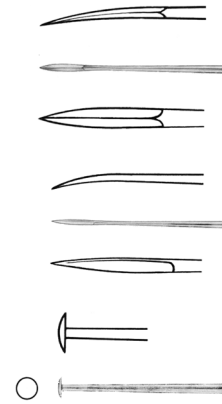

Number	Description	Size	Angle
O30953	Rosen incision knife		45°
O30955	Hough incision knife	2.0 x 1-2 mm	45°
O30958	House lancet knife	2.0 x 1.0 mm	45°
O30965	Shea incision knife	2.0 x 1.5 mm	90°
O30967	Austin incision knife	1.8 x 1.2 mm	90°

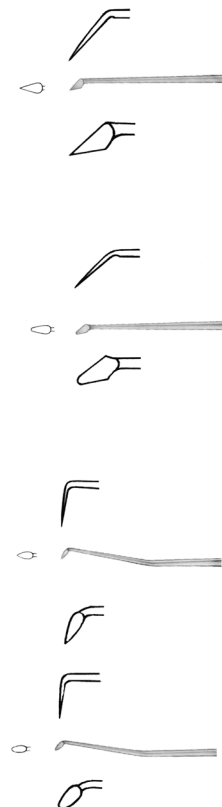



Number Description

O31003 Guilford-Wright flap knife 2 mm

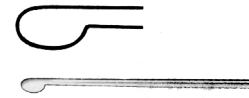

O31005 Plester flap knife 3.5 mm



O31017 Plester incision knife 2.5 mm

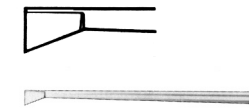

O31032 Austin sickle knife 3.0 x 1.0 mm

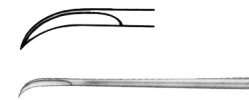

O31035 Austin incision knife for footplate



Number Description

O31040 Tabb tympanoplasty knife 1.5 x 1 - 1.15 mm

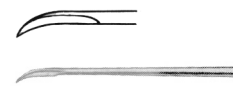

O31041 House sickle knife #1 6.0 x 1.5 mm

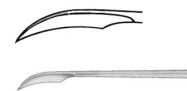

Number Description

O31046 Schuknecht sickle knife 5.0 x 1.0 mm

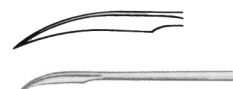

Number	Description	Width	Length
O31103	Goldmann elevator oval shape slight curve	2.5 mm	
O31111	House stapes elevator		12 mm
O31131	Shea elevator right	1.2 mm	
O31132	Shea elevator left	1.2 mm	

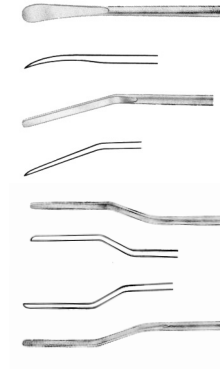

Number	Description	Length
O31171	Shambaugh-Derlacki elevator blunt	14 cm



Number	Description	Width
O30922	Austin round knife angled up 90°	2 mm Ø
O31102	Antoli-Candela elevator curved	1.8 mm
O31115	Rosen elevator	15 x 1.5 mm
O31121	Rosen elevator	15 x 1.0 mm
O31122	Rosen elevator	15 x 1.2 mm

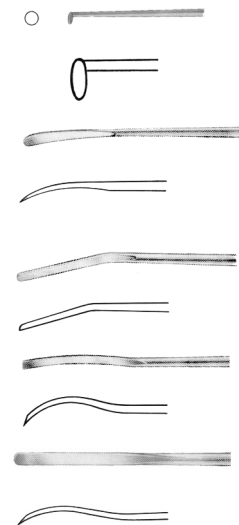



Number	Description			Width
O31143	Schuknecht elevator	flat	tip slightly curved up	1 mm
O31150	Hough excavator	heavy pattern	right	
O31151	Hough excavator	heavy pattern	left	

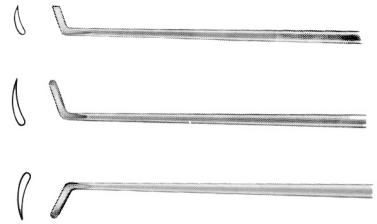

Number	Description		width	length
O31175	Shambaugh-Derlacki elevator	angled tip	2.0 mm	14.4 cm
O31176	Shambaugh-Derlacki duckbill elevator	slightly curved	3.0 mm	14.5 cm

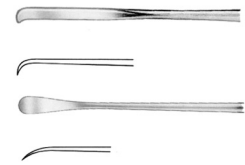

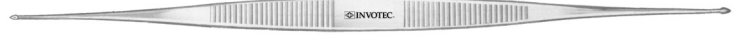

Number	Description			Length
O31290	Double-ended curette for Stapedectomy	pointed	small	17 cm
O31292	Double-ended curette for Stapedectomy	pointed	large	17 cm

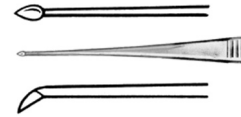

Number	Description		Diameter	
O31270	House Double-ended curette for stapedectomy	cups slightly angled forward	1.0 mm	1.2 mm
O31275	House Double-ended curette for stapedectomy	cups slightly angled forward	1.5 mm	1.8 mm
O31280	House Double-ended curette for stapedectomy	cups strongly angled forward	1.0 mm	1.2 mm
O31285	House Double-ended curette for stapedectomy	cups strongly angled forward	1.5 mm	1.8 mm

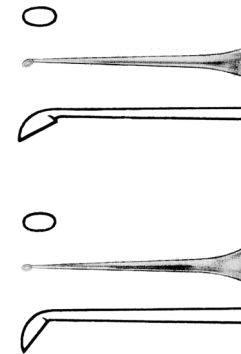



Number	Description	Diameter
O36590	Larkin hand perforator trocar point	0.8 mm
O36592	Larkin hand penetrator	0.8 mm
O36594	Larkin hand trephine	0.8 mm

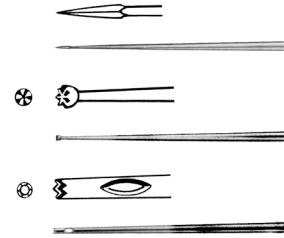



Number	Description	Width	Diameter
O31461	Rose Mobilizer	1.8 mm	

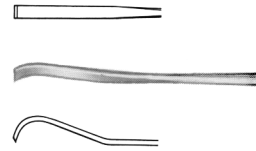

O31465	Goldmann Mobilizer with ball tip	angled up 25°	0.8 mm
--------	----------------------------------	---------------	--------



O31468	Goldmann pluggar with ball tip		1.0 mm
--------	--------------------------------	--	--------





Number	Description			
O31410	Hough measuring rod	markers at 3.5 mm	4 mm	4.5 mm

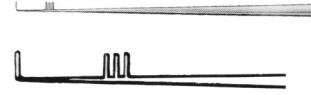

O31433	Austin wire guide and applicator	v-notch	light curve	
--------	----------------------------------	---------	-------------	--

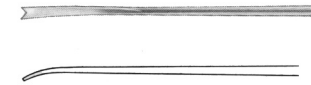

Number	Description
O38950	Piston cutting jig

R&GS ACC

DIS

OTO ACC

OSS

LAR ACC

SPE ACC

RHI INS

PSB

OTO INS

LAR INS

ORO/MAS TNS

LARYNGEAL INSTRUMENTS

KLEINSASSAR TYPE

Number	Size	Description
L30001	18 cm	Adult Large
L30002	18 cm	Medium
L30003	18 cm	Small
L30004	18 cm	Anterior commissure
L30005	22 cm	Anterior commissure, long neck
L30006	15 cm	Child
L30007	13 cm	Small Child

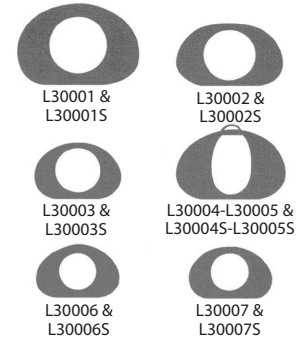
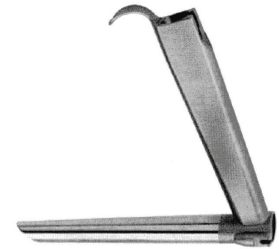

SPREADABLE OPERATING LARYNGOSCOPES

Number	Size	Description
L30001S	17 cm	Adult Large
L30002S	17 cm	Medium
L30003S	18 cm	Small
L30004S	18 cm	Anterior commissure
L30005S	22 cm	Anterior commissure, long neck
L30006S	15 cm	Child
L30007S	13 cm	Small Child



BENJAMIN SLIM

Number	Size	Description
L550-1327	17 cm	Adult Medium



LARYNGOSCOPE HOLDER AND CHEST SUPPORT

Number	Ring Size	Rod Size	Description
L30400	9.5 cm Ø	34 cm	Adult size chest support with rubber ring
L30500	9.5 cm Ø	24 cm	Child size rod only with rubber ring
L30401			Rubber ring replacement for L30400-L30500



LEWY LARYNGOSCOPE HOLDER

Number	Description
L30390	Lewy Laryngoscope holder and chest brace
L3039H	Lewy handle for Kleinsassar, spreadables and Benjamin Slim operating laryngoscopes



DEDO-PILLING MICRO LARYNGOSCOPE TYPE II

- Eliminates light loss though continuous illuminating fibers
- Supplied with two light carriers

Number	Size	Overall length	Minimum ID	Maximum OD	Description
L530-173	Adult	173 mm	11.6 mm	30.1 mm	Dedo-Pilling Micro Laryngoscope Type II

HOLINGER LARYNGOSCOPE

Number	Description	Working Length	Full Length
L740020	Adult Large	157 mm	180 mm
L550-1350	Adult Medium	146 mm	170 mm

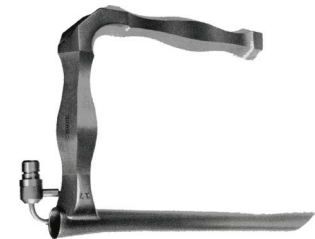
JACKSON LARYNGOSCOPE

Number	Description	Full Length
L740012	Infant Laryngoscope	120 mm
L740017	Child Laryngoscope	170 mm
L740018	Adult Laryngoscope	180 mm



FIBER OPTIC LIGHT CARRIERS

Number	Description	Compatible Laryngoscope Models
L30010	Large, Fiber Optic Light Carrier	Kleinsassar Type L30001 - L30005
L30011	Medium, Fiber Optic Light Carrier	Kleinsassar Type L30006 - L30007
L30012	X-Long, Fiber Optic Light Carrier	Kleinsassar Type L30005
L30013	Light carrier fittings - Storz	
L30014	Light carrier fittings - Wolfe	
L550-1330	Fiber Optic Light Carrier with clip for proximal illumination	

SUCTIONS

Number	Description	Compatible Laryngoscope Models
L30110	Suction / Smoke Evacuator	Kleinsassar Type L30001 - L30005
L30111	Suction / Smoke Evacuator	Kleinsassar Type L30006 - L30007

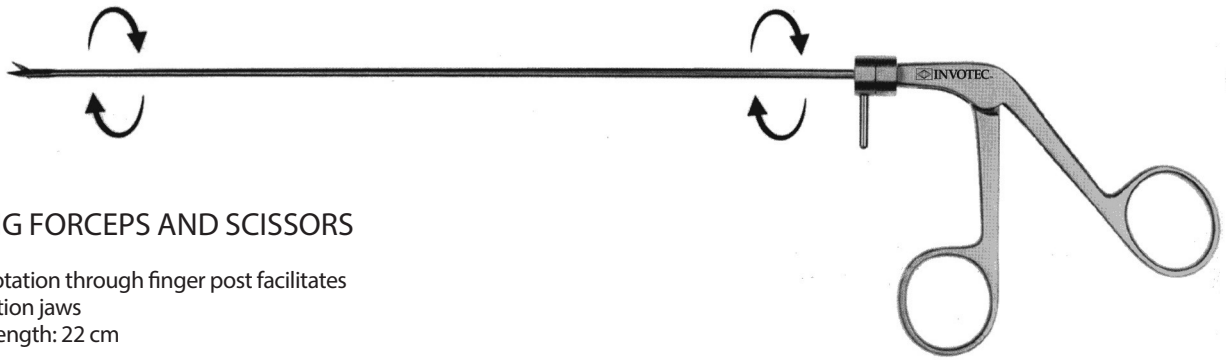



ROTATING FORCEPS AND SCISSORS

- Full 360° rotation through finger post facilitates
- Double action jaws
- Working Length: 22 cm

Forceps

Number	Description		
L32203	Cutting Forceps with round cupped double action jaws	2 mm Ø	curved
L32206	Alligator Forceps with serrated, double action jaws		curved
L32207	Grasping Forceps with triangular, serrated, double action jaws		curved upwards



Scissors

Number	Description	
L32210	Scissors	curved



ANTERIOR COMMISSURE FORCEPS AND SCISSORS

- Conical sheath for high stability and optimal view
- Optimum access in the anterior commissure via 10° upcurved distal end

Cutting Forceps

Number	Description		
L32101	Cutting Forceps with round, cupped jaws	2 mm Ø	straight
L32102	Cutting Forceps with round, cupped jaws	2 mm Ø	curved upwards
L32103	Cutting Forceps with round, cupped jaws	2 mm Ø	curved right
L32104	Cutting Forceps with round, cupped jaws	2 mm Ø	curved left



Scissors

Number	Description	
L32108	Scissors	straight
L32109	Scissors	upcurved 45°
L32110	Scissors	curved right
L32111	Scissors	curved left



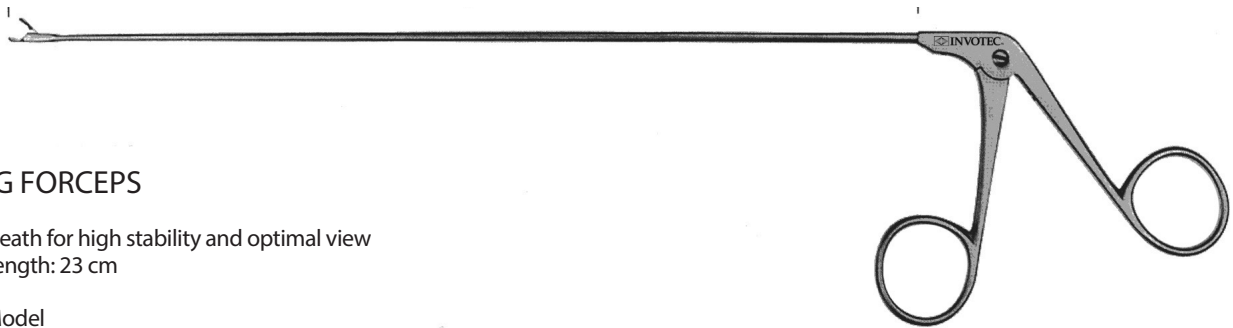

CUTTING FORCEPS

- Conical sheath for high stability and optimal view
- Working length: 23 cm

Standard Model

Number	Description		
L32001	Cutting Forceps with round cupped jaws	2 mm Ø	straight
L32002	Cutting Forceps with round cupped jaws	2 mm Ø	curved upwards
L32003	Cutting Forceps with round cupped jaws	2 mm Ø	curved right
L32004	Cutting Forceps with round cupped jaws	2 mm Ø	curved left
L32050	Cutting Forceps with round cupped jaws	2 mm Ø	curved upwards right
L32051	Cutting Forceps with round cupped jaws	2 mm Ø	curved upwards left
L32052	Cutting Forceps with round cupped jaws, horizontal opening	2 mm Ø	curved right
L32053	Cutting Forceps with round cupped jaws, horizontal opening	2 mm Ø	curved left
L32150	Cutting Forceps with long oval cupped jaws		curved upwards
L32151	Cutting Forceps with long oval cupped jaws, opening right		upcurved
L32152	Cutting Forceps with long oval cupped jaws, opening left		upcurved



Heavy Model

Number	Description		
L32040	Forceps with oval cupped jaws	3x5 mm	straight
L32041	Forceps with round cupped jaws	4 mm Ø	straight
L32042	Forceps with round cupped jaws	4 mm Ø	curved upwards
L32043	Forceps with round cupped jaws	4 mm Ø	curved right
L32044	Forceps with round cupped jaws	4 mm Ø	curved left



Double Action Model

Number	Description		
L32046	Cutting Forceps with round cupped, double action jaws	5 mm Ø	straight



Miniature, Very Delicate Model

Number	Description		
L32060	Miniature Cutting Forceps with cupped jaws	1 mm Ø	straight
L32061	Miniature Cutting Forceps with cupped jaws	1 mm Ø	curved upwards
L32062	Miniature Cutting Forceps with cupped jaws	1 mm Ø	curved right
L32063	Miniature Cutting Forceps with cupped jaws	1 mm Ø	curved left
L32064	Miniature Cutting Forceps with cupped jaws	1 mm Ø	curved upwards right
L 32065	Miniature Cutting Forceps with cupped jaws	1 mm Ø	curved upwards left

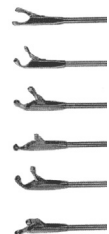

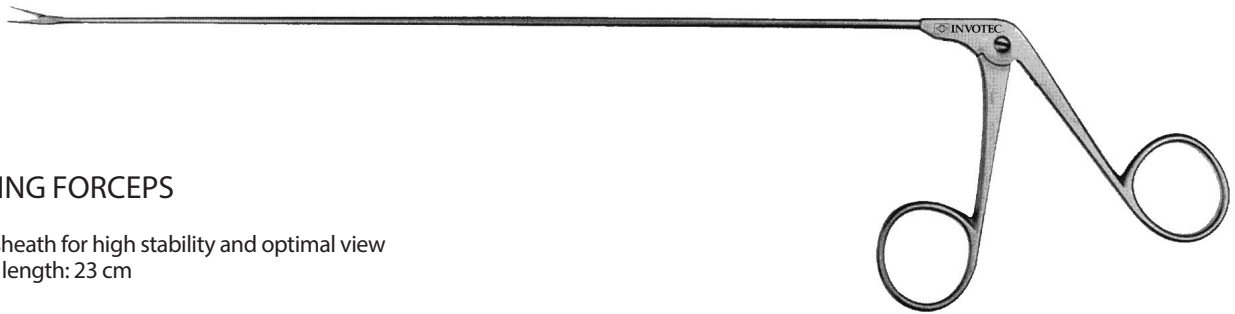

GRASPING FORCEPS

- Conical sheath for high stability and optimal view
- Working length: 23 cm

Standard Model

Number	Description		
L32105	Artery Forceps with ratchet	serrated	straight
L32005	Alligator Forceps	serrated	straight
L32006	Alligator Forceps	serrated	curved right
L32007	Alligator Forceps	serrated	curved left
L32215	Alligator Forceps, horizontal opening	serrated	straight
L32054	Alligator Forceps	serrated	curved up
L32154	Alligator Forceps, horizontal opening	serrated	curved up
L32055	Forceps with triangular jaws	curved up	opening right
L32056	Forceps with triangular jaws	curved up	opening left
L32058	Forceps with triangular jaws	straight	
L32059	Forceps with triangular jaws	curved up	
L32068	ARNOLD Vocal Cord Holding Forceps with triangular jaws		for right side
L32069	ARNOLD Vocal Cord Holding Forceps with triangular jaws		for left side

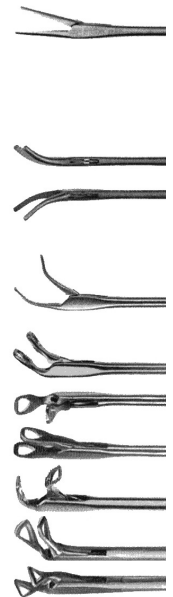

Miniature, Very Delicate Model

Number	Description		
L32070	Miniature Grasping Forceps	serrated	straight
L32071	Miniature Grasping Forceps	serrated	curved upwards
L32072	Miniature Grasping Forceps	serrated	curved right
L32073	Miniature Grasping Forceps	serrated	curved left
L32076	Miniature Grasping Forceps with triangular jaws	serrated	curved right
L32077	Miniature Grasping Forceps with triangular jaws	serrated	curved left

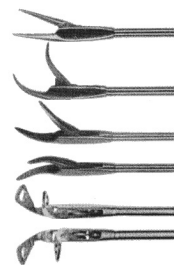



SCISSORS

- Conical sheath for high stability and optimal view
- Working length: 23 cm

Standard Model

Number	Description	
L32008	Scissors	straight
L32009	Scissors	curved up 45°
L32115	Scissors	curved up 15°
L32010	Scissors	curved right
L32011	Scissors	curved left
L32057	Scissors, horizontal cutting	straight

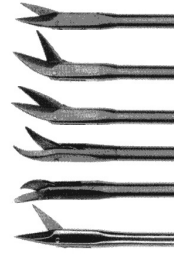

Miniature, Very Delicate Model

Number	Description	
L32080	Miniature Scissors	straight
L32081	Miniature Scissors	curved up 45°
L32082	Miniature Scissors	curved right
L32083	Miniature scissors	curved left

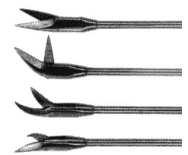

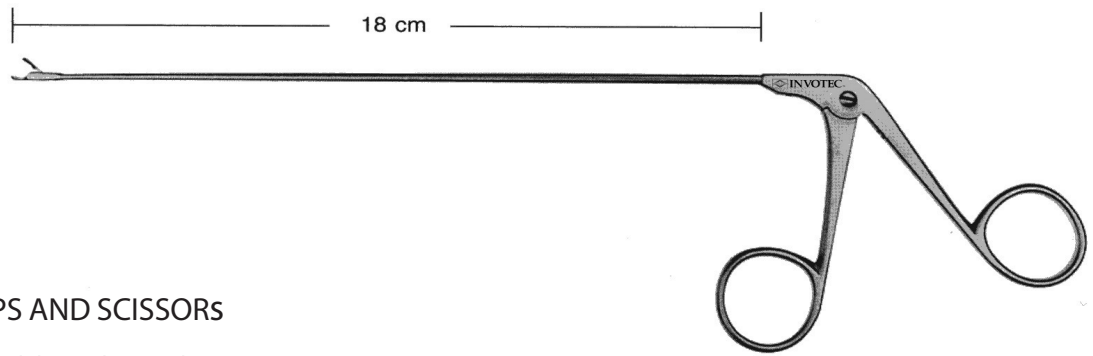

PEDIATRIC FORCEPS AND SCISSORS

- Conical sheath for high stability and optimal view
- Working length: 18 cm

Cutting Forceps

Number	Description		
L31902	Cutting Forceps with cupped jaws	2 mm Ø	straight
L31903	Cutting Forceps with cupped jaws	2 mm Ø	curved up
L31904	Cutting Forceps with cupped jaws	3 mm Ø	straight
L31905	Cutting Forceps with cupped jaws	3 mm Ø	curved up
L31906	Cutting Forceps with cupped jaws	1 mm Ø	straight
L31907	Cutting Forceps with cupped jaws	1 mm Ø	curved up
L31930	Cutting Forceps with cupped jaws with horizontal opening and malleable distal end	4 mm Ø	

Grasping Forceps

L31910	Alligator Forceps with serrated jaws	straight
--------	--------------------------------------	----------

Scissors

Number	Description	
L31920	Scissors	straight
L31921	Scissors	upcurved 45°
L31922	Scissors	curved right
L31923	Scissors	curved left





UNIPOLAR COAGULATION FORCEPS

- Unipolar coagulation
- 360° rotatable
- Laser smoke evacuation

Number	Description				Shaft	Working Length
L040023	Unipolar coagulation forceps with smoke evacuation channel	Rotatable	Serrated	Straight	3.0 mm	23 cm
L040223	Unipolar coagulation forceps with smoke evacuation channel	Rotatable	Serrated	Straight	3.0 mm	23 cm
L040423	Unipolar coagulation forceps with smoke evacuation channel	Rotatable	Serrated	Straight	3.0 mm	23 cm
L040623	Unipolar coagulation forceps with smoke evacuation channel	Rotatable	Serrated	Straight	3.0 mm	23 cm



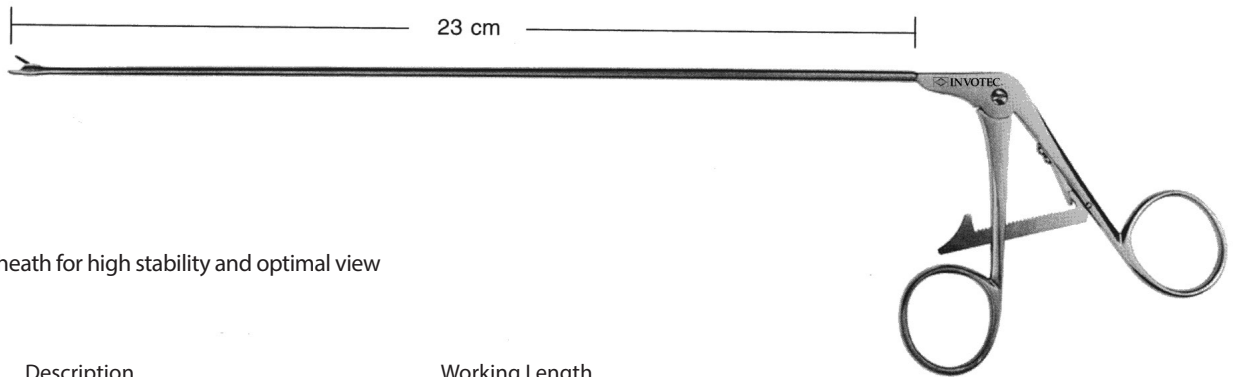

- Conical sheath for high stability and optimal view

Number	Description	Working Length
L32036	Needle Holder with ratchet, conical sheath	23 cm

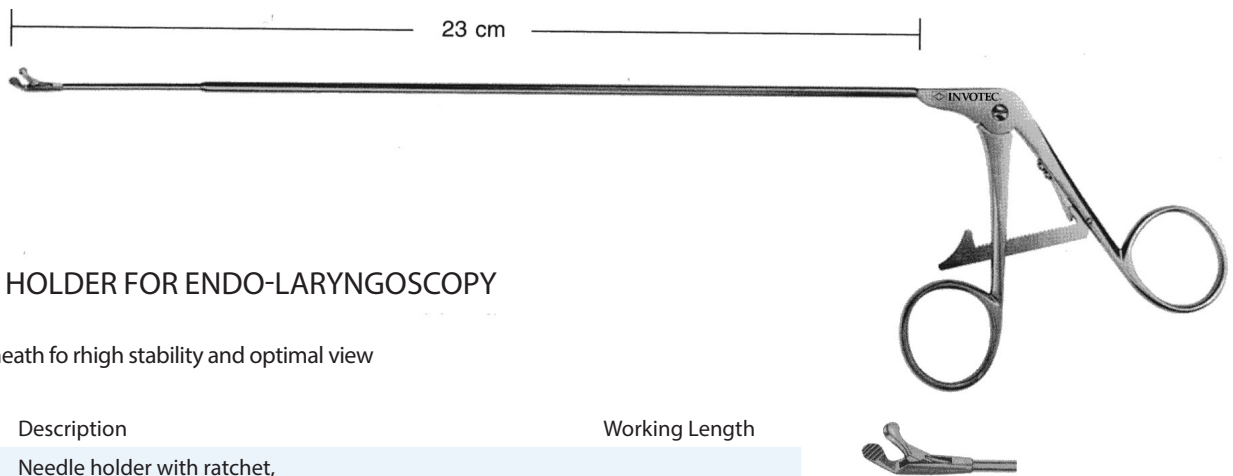

NEEDLE HOLDER FOR ENDO-LARYNGOSCOPY

- Conical sheath for high stability and optimal view

Number	Description	Working Length
L32037	Needle holder with ratchet, delicate with rounded, serrated jaws	1.6 mm Ø upcurved 23 cm



MICROSURGERY INSTRUMENTS

Number	Description
L32025	Handle for use with L32013-L32116

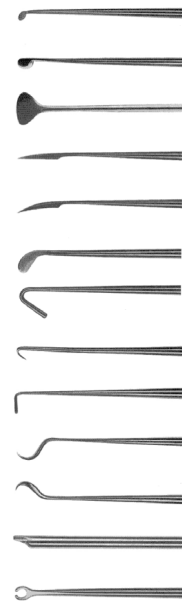
Number	Description
L32013	Knife Round 45° angle 2.5 mm Ø
L32014	Knife Round Verticle cutting
L32015	Knife Oval Straight
L32016	Knife Straight cutting
L32116	Knife Sickle shaped Curved
L32017	Knife Golf club shaped
L32018	Hook Blunt
L32019	Hook Sharp
L32024	Hook Probe end 90° angle
L32020	Needle Curved right
L32021	Needle Curved left
L32022	Elevator with suction channel
L32023	Knot Tier

JAKO ENDOLARYNGEAL MICROSURGERY

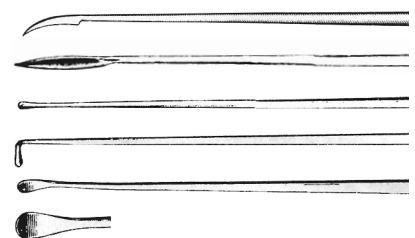
Number	Description
L44510	JAKO Laryngeal Sickle Knife Knife length: 8 mm
L44511	JAKO Laryngeal Knife Knife length: 8 mm
L44520	JAKO Laryngeal Probe
L44521	JAKO Laryngeal Hook
L44540	JAKO Laryngeal Dissector Blunt





MICRO LARYNGEAL BLADE HANDLE

- Collet designed to hold sterile micro blades

Number	Description	Working Length	Wing Dimension
60-44300	Harris Micro Laryngeal Blade Handle*	22.5 cm	42 x 25 mm

* Designed in conjunction with Thomas Harris MA FRCS. London, UK.

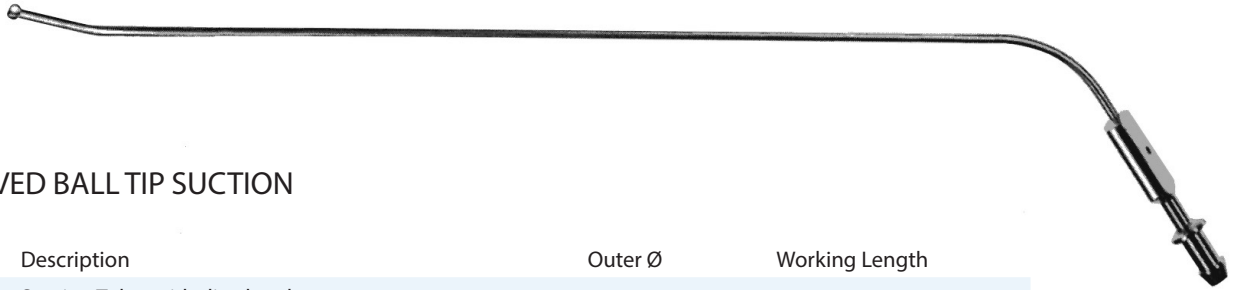
UPCURVED BALL TIP SUCTION

Number	Description	Tip	Outer Ø	Working Length
L32029	Suction Tube with distal end upcurved	Tip ball shape	2 mm	25 cm
L32039	Suction Tube with distal end upcurved	Tip ball Shape	3 mm	25 cm

PEDIATRIC SUCTION

Number	Description	Outer Ø	Working Length
L31932	Pediatric Suction Tube with ball end	2 mm	20 cm
L31933	Pediatric Suction Tube with ball end	3 mm	20 cm

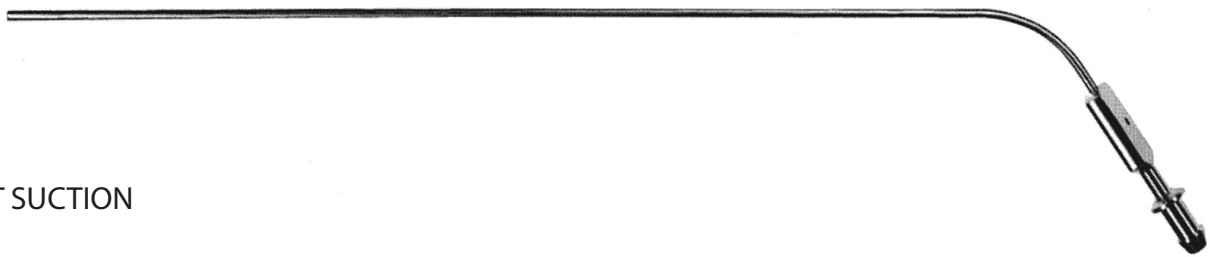
STRAIGHT SUCTION

Number	Description	Outer Ø	Working Length
L32026	Suction Tube	2 mm	25 cm
L32027	Suction Tube	2.5 mm	25 cm
L32028	Suction Tube	3 mm	25

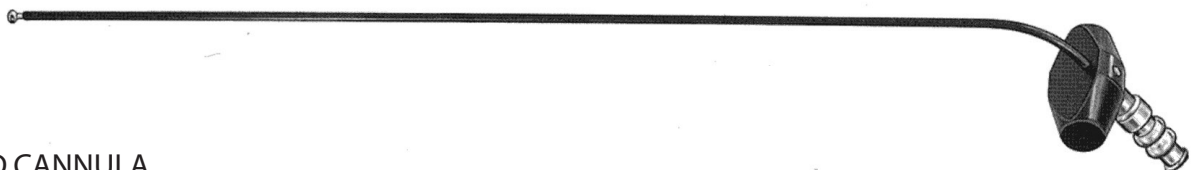

INSULATED CANNULA

Number	Description	Outer Ø
L32030	Insulated Cannula for suction and coagulation	3 mm

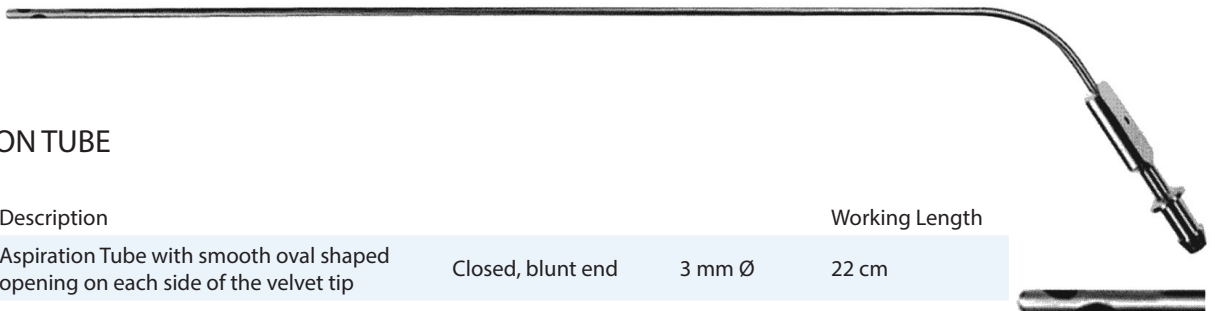

COTTON CARRIER

Number	Description	Working Length	Outer Ø
L32128	Cotton Carrier Twist end serrated	28 cm	2.5 mm



ASPIRATION TUBE

Number	Description	Working Length
L32220	Aspiration Tube with smooth oval shaped opening on each side of the velvet tip	Closed, blunt end 3 mm Ø 22 cm
L32221	Aspiration Tube with smooth oval shaped opening on each side of the velvet tip	Closed, blunt end 4 mm Ø 22 cm

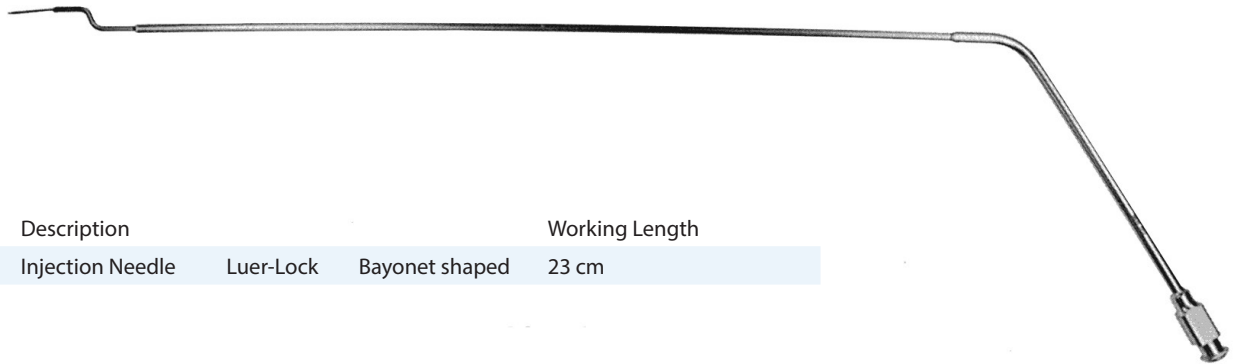

Number	Description	Working Length
L32130	Injection Needle Luer-Lock Bayonet shaped	23 cm

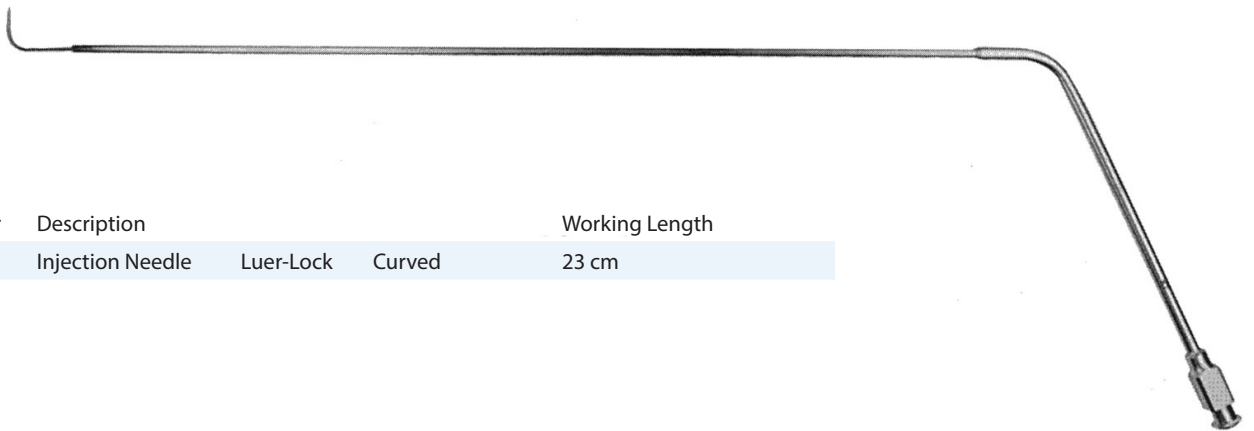

Number	Description	Working Length
L32131	Injection Needle Luer-Lock Curved	23 cm

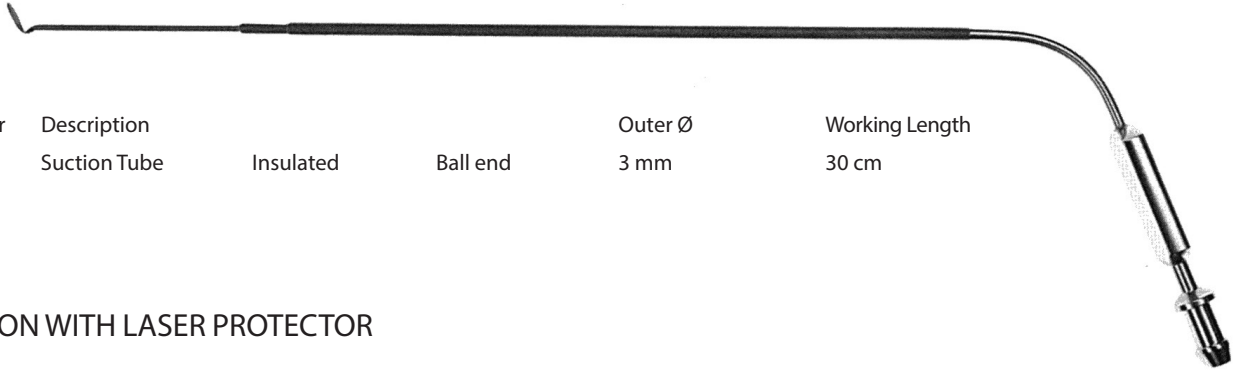

Number	Description	Insulated	Ball end	Outer Ø	Working Length
L41230	Suction Tube	Insulated	Ball end	3 mm	30 cm

SUCTION WITH LASER PROTECTOR

- Special black finish protects lower regions of the mucous membrane against laserbeam

Number	Description	Black	Round	Upcurved	3 mm Ø	Working Length
L41003	Suction Tube with laser-protector and smoke evacuation channel	Black	Round	Upcurved	3 mm Ø	23 cm
L41004	Suction Tube with laser-protector and smoke evacuation channel	Black	Round	Upcurved	4 mm Ø	23 cm
L41005	Suction Tube with laser-protector and smoke evacuation channel	Black	Round	Upcurved	5 mm Ø	23 cm
L41007	Suction Tube with laser-protector and smoke evacuation channel	Black	Oval	Upcurved	7 mm Ø	23 cm
L41009	Suction Tube with laser-protector and smoke evacuation channel, distal suction hole left side	Black	Oval	Straight		23 cm
L41010	Suction Tube with laser-protector and smoke evacuation channel, distal suction hole right side	Black	Oval	Straight		23 cm
L41011	Suction Tube with laser-protector and smoke evacuation channel, distal suction hole left side	Black	Corner Shaped			23 cm
L41012	Suction Tube with laser-protector and smoke evacuation channel, distal suction hole right side	Black	Corner Shaped			23 cm
L41013	Suction Tube with laser-protector and smoke evacuation channel, distal suction hole left side	Black	Bayonet Shaped			23 cm
L41014	Suction Tube with laser-protector and smoke evacuation channel, distal suction hole left side	Black	Bayonet Shaped			23cm
L41016	Suction Tube with laser-protector and smoke evacuation channel for larynx and trachea	Black	Upcurved		10x10 mm	26 cm
L41017	Suction Tube with laser-protector and smoke evacuation channel for hypopharyngeal diverticulum, slightly upcurved and 7 mm wide	Black	Upcurved		10x10 mm	23cm

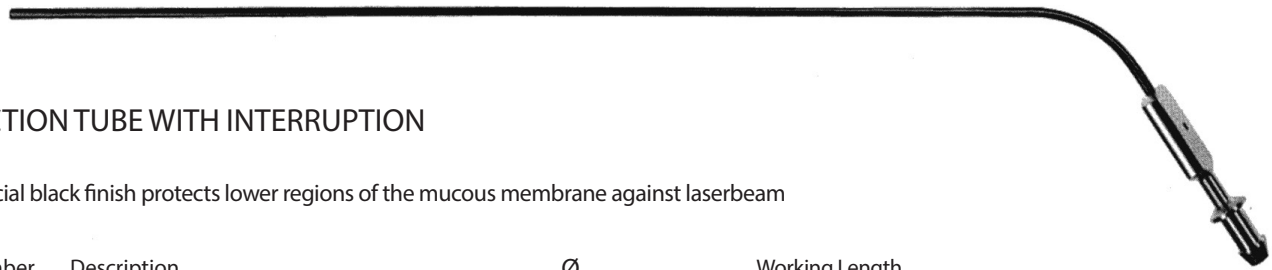

SUCTION TUBE WITH INTERRUPTION

- Special black finish protects lower regions of the mucous membrane against laserbeam

Number	Description		Ø	Working Length
L41025	Suction Tube with interruption	Black	2.5 mm	23 cm
L41030	Suction Tube with interruption	Black	3 mm	23 cm

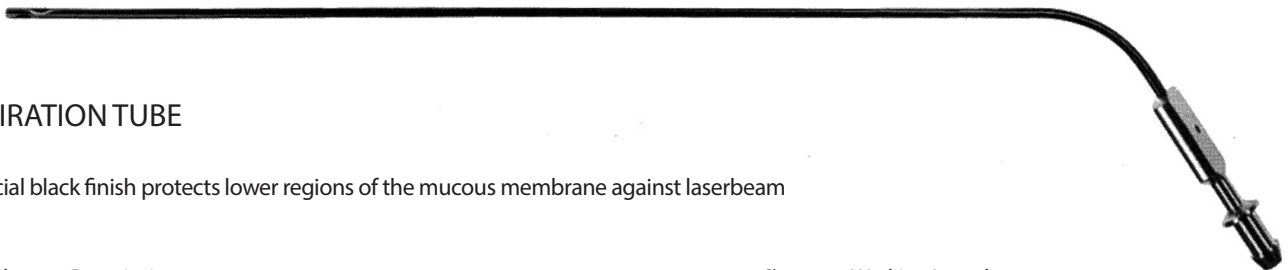
ASPIRATION TUBE

- Special black finish protects lower regions of the mucous membrane against laserbeam

Number	Description			Ø	Working Length
L41033	Aspiration Tube with smooth oval shaped opening on each side of velvet tip	Black	Closed, blunt end	3 mm	22 cm

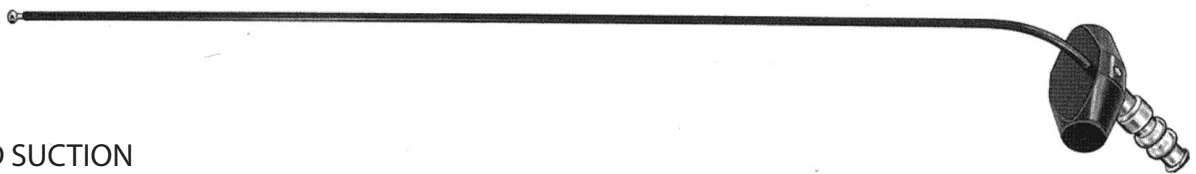
INSULATED SUCTION

Number	Description		Ø	Working Length
L41130	Insulated Suction and coagulation cannula	Unipolar	3 mm Ø	23 cm

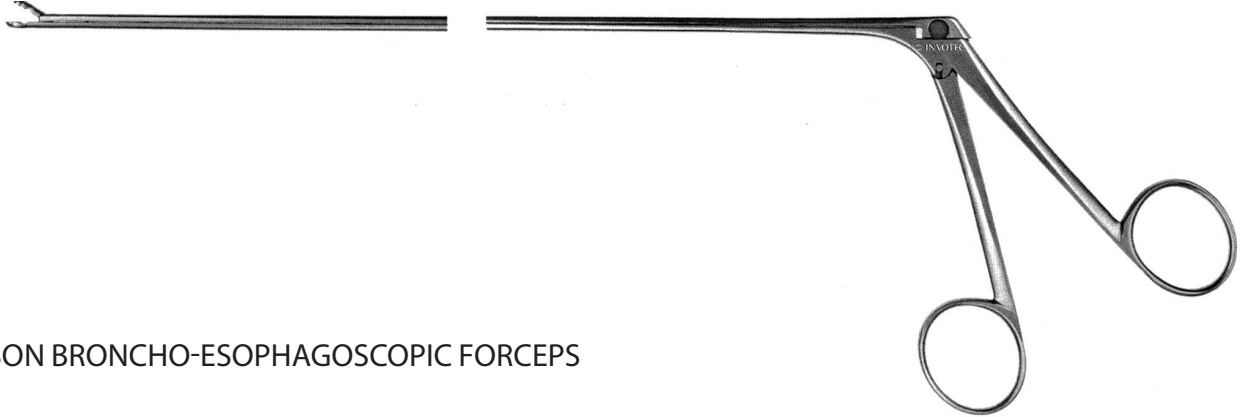

INSULATED SUCTION

Number	Description			Outer Ø	Working Length
L41225	Suction Tube	Insulated	Ball end	2.5 mm	30 cm

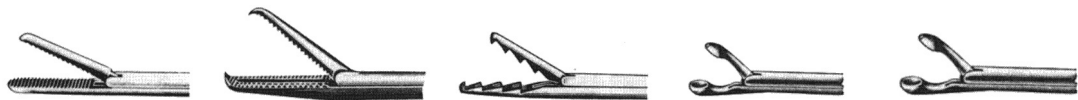

JACKSON BRONCHO-ESOPHAGOSCOPIC FORCEPS

Single Action Jaws



Shaft Length				2 mm Ø	4 mm Ø
30 cm	L31304	L31305	L31306	L31312	L31313
40 cm	L31404	L31405	L31406	L31412	L31413
50 cm	L31504	L31505	L31506	L31512	L31513
60 cm	L31604	L31605	L31606	L31612	L31613

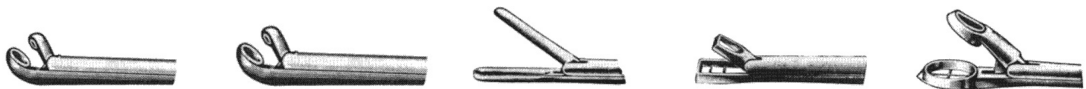







Shaft Length	2 mm Ø	4 mm Ø			
30 cm	L31317	L31319	L31320	L31331	L31335
40 cm	L31417	L31419	L31420	L31431	L31435
50 cm	L31517	L31519	L31520	L31531	L31535
60 cm	L31617	L31619	L31620	L31631	L31635

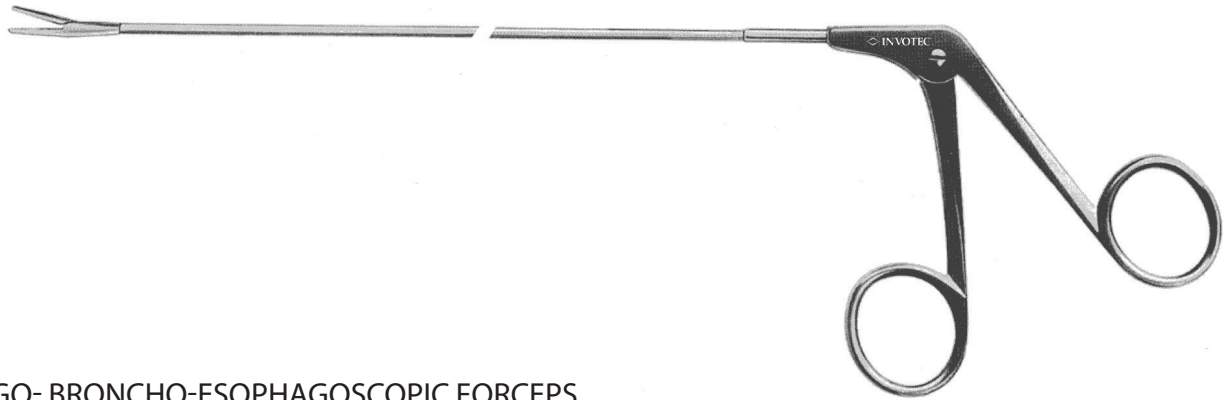

Double Action Jaws





Shaft Length						
30 cm	L32304	L32306	L32314	L32320	L31331	L32335
40 cm	L32404	L32406	L32414	L32420	L32431	L32435
50 cm	L32504	L32506	L32514	L32520	L32531	L32535
60 cm	L32604	L32606	L32614	L32620	L32631	L32635

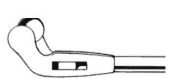
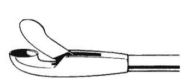
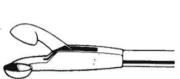





LARYNGO- BRONCHO-ESOPHAGOSCOPIC FORCEPS

Shaft Length					
40 cm	L40850	L40862	L40864	L40866	L40876
50 cm	L50850	L50862	L50864	L50866	L50876
60 cm	L60850	L60862	L60864	L60866	L60876

Shaft Length					
40 cm	L40878	L40879	L40882	L40884	L40890
50 cm	L50878	L50879	L50882	L50884	L50890
60 cm	L60878	L60879	L60882	L60884	L60890

Shaft Length			
40 cm	L40892	L40894	L40896
50 cm	L50892	L50894	L50896
60 cm	L60892	L60894	L60896

Child Sizes

Shaft Length						
35 cm	L35710	L35730	L35732	L35790	L35792	L35793

Shaft Length					
35 cm	L35794	L35796	L35812	L35814	L35816

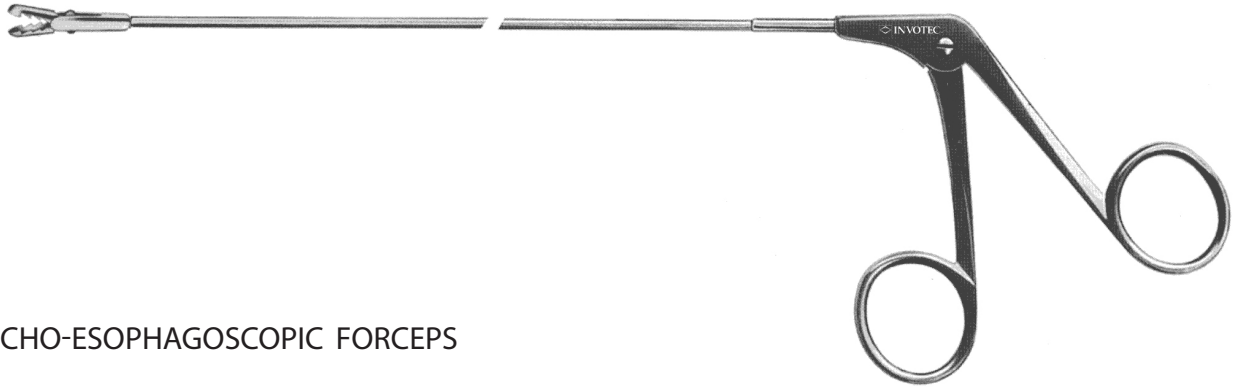

BRONCHO-ESOPHAGOSCOPIC FORCEPS

- Double action jaws



Shaft Length	1.5 mm Ø	1.5 mm Ø	1.5mm Ø	1.5 mm Ø
25 cm	L85125	L85225	L85325	L85425
35 cm	L85135	L85235	L85335	L85435
Shaft Length	2.0 mm Ø	2.0 mm Ø	2.0 mm Ø	2.0 mm Ø
35 cm	L85140	L85240	L85340	L85440
Shaft Length	2.5 mm Ø	2.5 mm Ø	2.5 mm Ø	2.5 mm Ø
55 cm	L85150	L85250	L85350	L85450

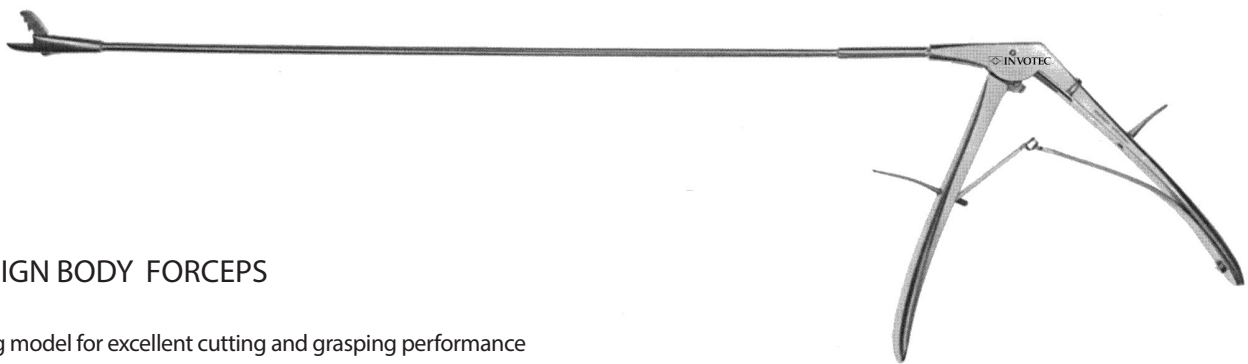

FOREIGN BODY FORCEPS

- Strong model for excellent cutting and grasping performance
- Cuts up to 1.2mm Ø wires

Shaft Length	2.5 mm Ø
35 cm	L85535
45 cm	L85545

FLEXIBLE ENDOSCOPY

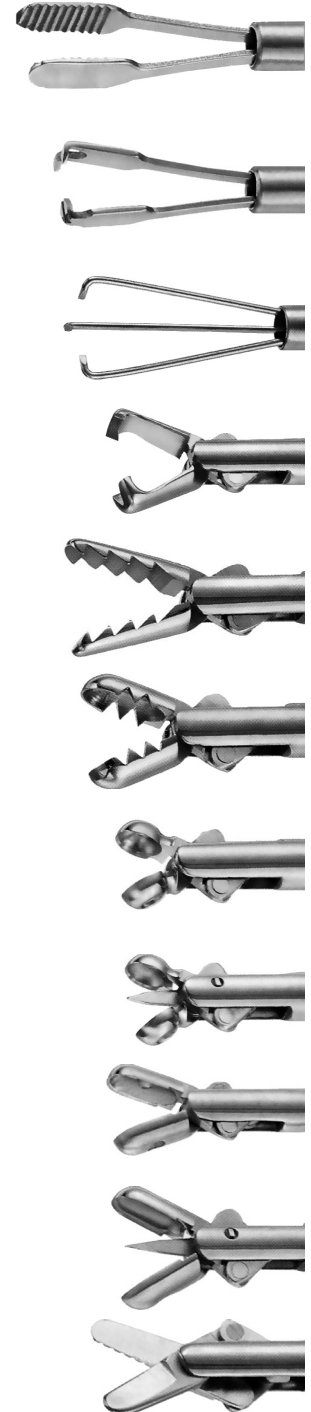

- Stainless steel
- Spiral of highest flexibility
- Solidly constructed handles
- Autoclavable by all the conventional methods

Serrated	90 cm	120 cm	150 cm	180 cm	230 cm
1.8 mm Ø	L47005	L47025	L47055	L47085	L47095
2.3 mm Ø	L47007	L47027	L47057	L47087	L47097
2x2 Teeth	90 cm	120 cm	150 cm	180 cm	230 cm
1.8 mm Ø	L47205	L47225	L47255	L47285	L47295
2.3 mm Ø	L47207	L47227	L47257	L47287	L47297
Three Clawed	90 cm	120 cm	150 cm	180 cm	230 cm
1.8 mm Ø	L47305	L47325	L47355	L47385	L47395
2.3 mm Ø	L47307	L47327	L47357	L47387	L47397
1x2 Teeth	90 cm	120 cm	150 cm	180 cm	230 cm
1.8 mm Ø	L47605	L47625	L47655	L47685	L47695
2.3 mm Ø	L47607	L47627	L47657	L47687	L47697
Pike Teeth	90 cm	120 cm	150 cm	180 cm	230 cm
1.8 mm Ø	L47805	L47825	L47855	L47885	L47895
2.3 mm Ø	L47807	L47827	L47857	L47887	L47897
Serrated Cup Jaws	90 cm	120 cm	150 cm	180 cm	230 cm
1.8 mm Ø	L47905	L47925	L47955	L47985	L47995
2.3 mm Ø	L47907	L47927	L47957	L47987	L47997
Round Cup Jaws	90 cm	120 cm	150 cm	180 cm	230 cm
1.8 mm Ø	L48005	L48025	L48055	L48085	L48095
2.3 mm Ø	L48007	L48027	L48057	L48087	L48097
Round Cup Jaws with Pin	90 cm	120 cm	150 cm	180 cm	230 cm
2.3 mm Ø	L48107	L48127	L48157	L48187	L48197
Oval Cup Jaws	90 cm	120 cm	150 cm	180 cm	230 cm
1.8 mm Ø	L48205	L48225	L48255	L48285	L48295
2.3 mm Ø	L48207	L48227	L48257	L48287	L48297
Oval Cup Jaws with Pin	90 cm	120 cm	150 cm	180 cm	230 cm
2.3 mm Ø	L48307	L48327	L48357	L48387	L48397
1 Blade Serrated	90 cm	120 cm	150 cm	180 cm	230 cm
2.3 mm Ø	L48807	L48827	L48857	L48887	L48897

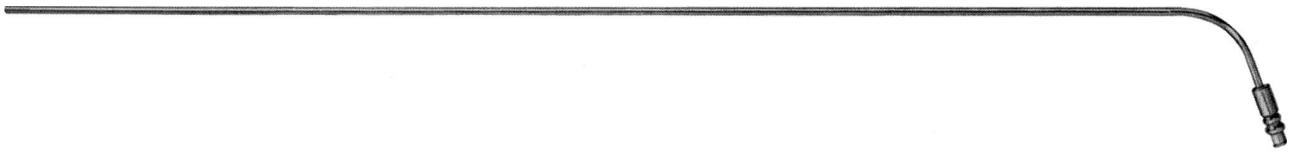

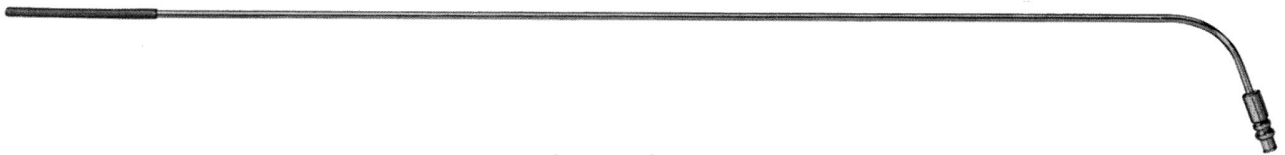

Number	Description		Working Length
L18035	Rigid Suction Tube	2.5 mm Ø	25 cm
L18050	Rigid Suction Tube	4 mm Ø	50 cm



Number	Description		Working Length
L18135	Rigid Suction Tube with flexible rubber tip		35 cm
L18150	Rigid Suction Tube with flexible rubber tip		50 cm



COTTON CARRIERS

Number	Description	Working Length
L18335	Cotton Carrier	35 cm
L18350	Cotton Carrier	50 cm

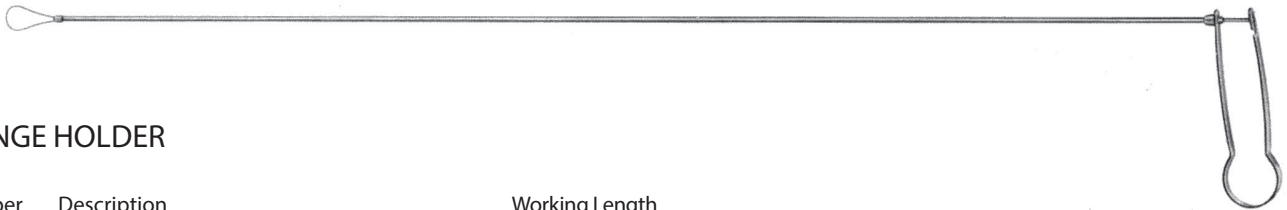

SPONGE HOLDER

Number	Description	Working Length
L18440	Sponge Holder 1 x 2 teeth	38 cm

TEETH PROTECTORS

- Can also be used as inlet for metal teeth protector (non-autoclavable)

Number	Description
L96050	Plastic Teeth Protector



R&CS ACC

DIS

OTO ACC

OSS

LAR ACC

SPE ACC

RHI INS

PSB

OTO INS

LAR INS

ORO/NAS INS

ORO-NASOPHARYNGEAL

INSTRUMENTS

LA FORCE ADENOTOME

Number	Description		Working Length
L11110	Adenotome by La Force	Size 0	23.5 cm
L11111	Adenotome by La Force	Size 1	23.5 cm
L11112	Adenotome by La Force	Size 2	23.5 cm
L11113	Adenotome by La Force	Size 3	23.5 cm



SHAMBAUGH ADENOTOME

Number	Description		Working Length
L11150	Adenotome by Shambaugh	Size 0	23.5 cm
L11151	Adenotome by Shambaugh	Size 1	23.5 cm
L11152	Adenotome by Shambaugh	Size 2	23.5 cm
L11153	Adenotome by Shambaugh	Size 3	23.5 cm



ADENOTOME REPLACEMENT BLADES

Number	Description		Length
L11190	Replacement blades	Size 0	10mm
L11191	Replacement blades	Size 1	13 mm
L11192	Replacement blades	Size 2	16 mm
L11193	Replacement blades	Size 3	19 mm



BECKMANN ADENOID CURRETTE

Number	Description			Blade Width	Overall Length
L40200	Reverse Curve Curette	Size 0	Straight	10.5 mm	22 cm
L40201	Reverse Curve Curette	Size 1	Straight	13 mm	22 cm
L40202	Reverse Curve Curette	Size 2	Straight	14.5 mm	22 cm
L40203	Reverse Curve Curette	Size 3	Straight	16 mm	22 cm
L40204	Reverse Curve Curette	Size 4	Straight	18 mm	22 cm
L40205	Reverse Curve Curette	Size 5	Straight	20.5 mm	22 cm

Number	Description			Blade Width	Overall Length
L13460	Reverse Curve Curette with basket	Size 1	Straight	10 mm	22 cm
L13461	Reverse Curve Curette with basket	Size 2	Straight	11 mm	22 cm
L13462	Reverse Curve Curette with basket	Size 3	Straight	12 mm	22 cm
L13463	Reverse Curve Curette with basket	Size 4	Straight	13 mm	22 cm
L13465	Reverse Curve Curette with basket	Size 5	Straight	15 mm	22 cm
L13466	Reverse Curve Curette with basket	Size 6	Straight	16 mm	22 cm

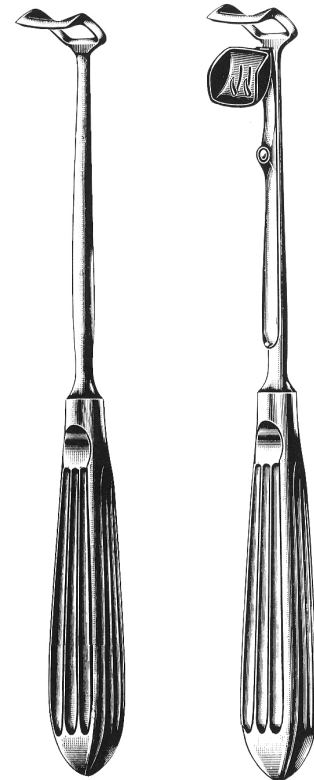
SHAMBAUGH ADENOID CURRETTE

Number	Description			Blade Width	Overall Length
L14710	Adenoid Curette	Size 0	Curved backwards	10 mm	22 cm
L14712	Adenoid Curette	Size 2	Curved backwards	12 mm	22 cm
L14714	Adenoid Curette	Size 3	Curved backwards	13 mm	22 cm
L14716	Adenoid Curette	Size 4	Curved backwards	15 mm	22 cm
L14718	Adenoid Curette	Size 5	Curved backwards	16 mm	22 cm

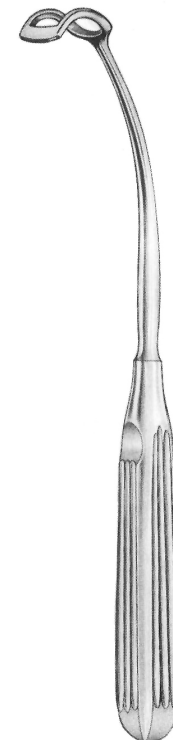



ST. CLAIR-THOMSON ADENOID CURRETTE

Number	Description			Blade Width	Overall Length
L40300	Reverse Curve Curette with basket	Size 0	Straight	10.5 mm	22 cm
L40301	Reverse Curve Curette with basket	Size 1	Straight	13 mm	22 cm
L40302	Reverse Curve Curette with basket	Size 2	Straight	14.5 mm	22 cm
L40303	Reverse Curve Curette with basket	Size 3	Straight	16.5 mm	22 cm
L40304	Reverse Curve Curette with basket	Size 4	Straight	18 mm	22 cm
L40305	Reverse Curve Curette with basket	Size 5	Straight	20.5 mm	22 cm



BARNHILL ADENOID CURRETTE

Number	Description			Blade Width	Overall Length
L40400	Adenoid Curette	Size 0	Curved	10.5 mm	21.5 cm
L40401	Adenoid Curette	Size 1	Curved	13 mm	21.5 cm
L40402	Adenoid Curette	Size 2	Curved	14.5 mm	21.5 cm
L40403	Adenoid Curette	Size 3	Curved	16.5 mm	21.5 cm
L40404	Adenoid Curette	Size 4	Curved	18 mm	21.5 cm



JONES ADENOID CURRETTE

Number	Description			Blade Width	Overall Length
L40701	Adenoid Curette	Infant	Straight	4 mm	22.5 cm
L40702	Adenoid Curette	Child	Straight	6 mm	22.5 cm
L40703	Adenoid Curette	Adult	Straight	8 mm	22.5 cm



VOGEL ADENOID CURRETTE

Number	Description			Blade Width	Overall Length
L40800	Adenoid Curette	Infant	Curved	9 x 12 mm	21.5 cm

MIDDLETON ADENOID CURRETTE

Number	Description		Blade Width	Overall Length
L40850	Long and Narrow Adenoid Curette	25 x 10 mm	7 mm	22.5 cm

STUBBS ADENOID CURRETTE

Number	Description			Blade Width	Overall Length
L40900	Adenoid Curette with angulated shaft	Size 0	Curved	11 mm	22 cm
L40901	Adenoid Curette with angulated shaft	Size 1	Curved	14 mm	22 cm
L40902	Adenoid Curette with angulated shaft	Size 2	Curved	16 mm	22 cm
L40903	Adenoid Curette with angulated shaft	Size 3	Curved	18 mm	22 cm

BECKMANN DISPOSIBLE ADENOID CURRETTE

• Sterile

Number	Description			Blade Width	Overall Length
25-2110	Adenoid Curette without basket	Size 1	Straight	10 mm	22 cm
25-2120	Adenoid Curette without basket	Size 2	Straight	11 mm	22 cm
25-2130	Adenoid Curette without basket	Size 3	Straight	12 mm	22 cm
25-2140	Adenoid Curette without basket	Size 4	Straight	13 mm	22 cm

LARYNGEAL MIRROR ON HANDLE

- Autoclavable
- Stainless Steel

Number	Description	Size	Diameter
L34806	Mirror attached on handle	000	6 mm
L34808	Mirror attached on handle	00	8 mm
L34810	Mirror attached on handle	0	10 mm
L34812	Mirror attached on handle	1	12 mm
L34814	Mirror attached on handle	2	14 mm
L34816	Mirror attached on handle	3	16 mm
L34818	Mirror attached on handle	4	18 mm
L34820	Mirror attached on handle	5	20 mm
L34822	Mirror attached on handle	6	22 mm
L34824	Mirror attached on handle	7	24 mm
L34826	Mirror attached on handle	8	26 mm
L34828	Mirror attached on handle	9	28 mm
L34830	Mirror attached on handle	10	30 mm

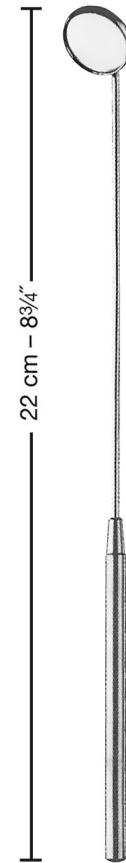

LARYNGEAL MIRROR AND HANDLE

- Autoclavable
- Stainless Steel
- For use with octagonal handle L53700

Number	Description	Size	Diameter
L53620	Mirror with threaded shaft	00	8 mm
L53600	Mirror with threaded shaft	0	10 mm
L53601	Mirror with threaded shaft	1	12 mm
L53602	Mirror with threaded shaft	2	14 mm
L53603	Mirror with threaded shaft	3	16 mm
L53604	Mirror with threaded shaft	4	18 mm
L53605	Mirror with threaded shaft	5	20 mm
L53606	Mirror with threaded shaft	6	22 mm
L53607	Mirror with threaded shaft	7	24 mm
L53608	Mirror with threaded shaft	8	26 mm
L53609	Mirror with threaded shaft	9	28 mm
L53610	Mirror with threaded shaft	10	30 mm

Number	Description	Overall Length
L53700	Octagonal mirror handle For use with mirrors L53600-L53620	75 mm



RHODIUM LARYNGEAL MIRROR AND HANDLE

- Autoclavable
- Stainless Steel
- For use with octagonal handle L54100

Number	Description	Size	Diameter
L54320	Rhodium plated mirror with standard shaft	00	8 mm
L54300	Rhodium plated mirror with standard shaft	0	10 mm
L54301	Rhodium plated mirror with standard shaft	1	12 mm
L54302	Rhodium plated mirror with standard shaft	2	14 mm
L54303	Rhodium plated mirror with standard shaft	3	16 mm
L54304	Rhodium plated mirror with standard shaft	4	18 mm
L54305	Rhodium plated mirror with standard shaft	5	20 mm
L54306	Rhodium plated mirror with standard shaft	6	22 mm
L54307	Rhodium plated mirror with standard shaft	7	24 mm
L54308	Rhodium plated mirror with standard shaft	8	26 mm
L54309	Rhodium plated mirror with standard shaft	9	28 mm
L54310	Rhodium plated mirror with standard shaft	10	30 mm

Number	Description	Overall Length
L54100	Octagonal, stainless steel mirror handle For use with mirrors L53600-L54320	75 mm



MICHEL RHINOSCOPIC MIRROR WITH HANDLE

- Autoclavable
- Stainless Steel
- Thumb mirror orientation control

Number	Description	Size	Diameter	Length
L54110	Michel Mirror with handle	0	10 mm	29 mm
L54112	Michel Mirror with handle	1	12 mm	29 mm
L54114	Michel Mirror with handle	2	14 mm	29 mm
L54116	Michel Mirror with handle	3	16 mm	29 mm
L54118	Michel Mirror with handle	4	18 mm	29 mm

Spare Mirrors for Michel Rhinoscopic Mirror with Handle

Number	Description	Size	Diameter
L54120	Spare Mirror for Michel Rhinoscopic Mirrors	0	10 mm
L54122	Spare Mirror for Michel Rhinoscopic Mirrors	1	12 mm
L54124	Spare Mirror for Michel Rhinoscopic Mirrors	2	14 mm
L54126	Spare Mirror for Michel Rhinoscopic Mirrors	3	16 mm
L54128	Spare Mirror for Michel Rhinoscopic Mirrors	4	18 mm

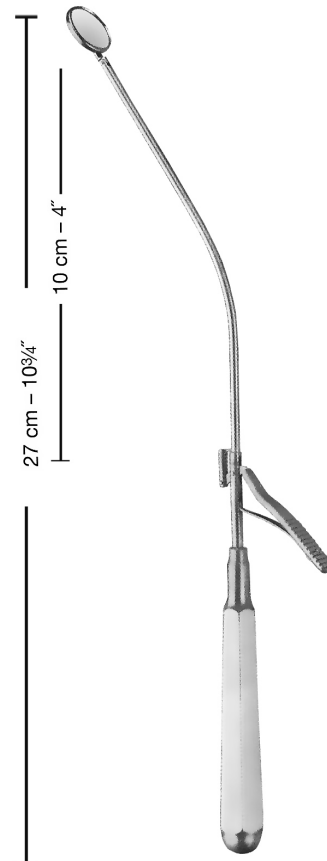

JENNINGS MOUTH GAG

- Stainless Steel

Number	Description		Working Length
N20009	Mouth Gag by Jennings	Open type	9 cm
N20011	Mouth Gag by Jennings	Open type	11 cm
N20013	Mouth Gag by Jennings	Open type	13 cm

Number	Description		Working Length
N23009	Mouth Gag by Jennings	Standard type	9 cm
N23011	Mouth Gag by Jennings	Standard type	11 cm
N23013	Mouth Gag by Jennings	Standard type	13 cm
N23015	Mouth Gag by Jennings	Standard type	15 cm



HEISTER MOUTH GAG

Number	Description	Working Length
N20505	Mouth Gag by Heister	13 cm

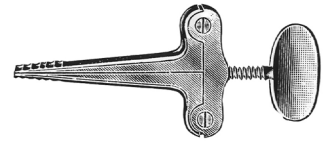

MOLT MOUTH GAG

Number	Description		Working Length
N20510	Mouth Gag by Molt	Child Size	10 cm
N20515	Mouth Gag by Molt	Adult Size	15 cm

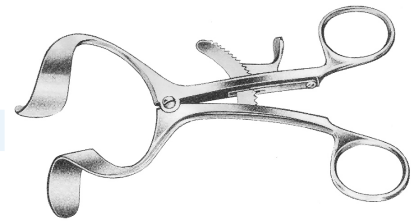

ROSER KÖNIG MOUTH GAG

Number	Description	Working Length
N20545	Mouth Gag by Roser König	16 cm



DENHART MOUTH GAG

Number	Description	Working Length
N20560	Mouth Gag by Denhart	13 cm

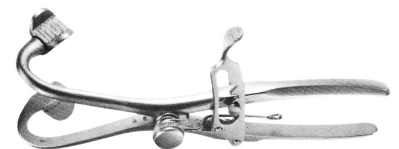

WHITEHEAD MOUTH GAG

Number	Description	Working Length
N20729	Mouth Gag by Whitehead	9 cm
N20731	Mouth Gag by Whitehead	11 cm
N20733	Mouth Gag by Whitehead	13 cm
N20735	Mouth Gag by Whitehead	15 cm

DINGMAN MOUTH GAG

- Stainless Steel

Number	Description
N20800	Dingman Mouth Gag Complete Set including: Frame with 4 spiral springs for the suspension of the thread ends, 2 Movable Tooth Hooks, 2 Cheek Retractors, and 3 Tongue Depressors (1 of each #1-3)
N20820	Dingman Mouth Gag Frame with 4 spiral springs for the suspension of the thread ends, 2 Movable Tooth Hooks and 2 Cheek Retractors

DINGMAN TONGUE DEPRESSORS

Number	Description	Size	Working Length
N20811	Tongue Depressor	Size 1	55 x 25 mm
N20812	Tongue Depressor	Size 2	60 x 27 mm
N20813	Tongue Depressor	Size 3	70 x 30 mm

SEEMANN-SEIFFERT MOUTH GAG

- Stainless Steel

Number	Description	Size	Working Length
N22009	Self retaining Mouth Gag by Seemann-Seiffert	Small / Child	9 cm
N22011	Self retaining Mouth Gag by Seemann-Seiffert	Standard	11 cm
N22013	Self retaining Mouth Gag by Seemann-Seiffert	Large	13 cm
N20755	Self retaining Mouth Gag by Seemann-Seiffert	X-Large	15 cm



Number	Description	Working Length
N24011	Standard Model Mouth Gag by Seemann-Seiffert	11 cm
N24013	Standard Model Mouth Gag by Seemann-Seiffert	13 cm

DAVIS-BOYLE MOUTH GAG

- Stainless Steel

Number	Description	
N26000	Left frame for Mouth Gag by Davis-Boyle	
N26200	Right Frame for Mouth Gag by Davis-Boyle	
N26300	Left frame for Mouth Gag by Davis-Boyle	Child size

Number	Description
N26010	Silicone Bit Liners Removable for Davis-Boyle Autoclavable (Sold in pairs)



DAVIS-BOYLE TONGUE DEPRESSOR

- Stainless Steel

Number	Description		Length	
N26001	Tongue Depressor by Davis-Boyle with smooth blades	Size 1	20 x 30 mm	13.5 cm
N26002	Tongue Depressor by Davis-Boyle with smooth blades	Size 2	23 x 65 mm	13.5 cm
N26003	Tongue Depressor by Davis-Boyle with smooth blades	Size 3	24 x 80 mm	13.5 cm
N26004	Tongue Depressor by Davis-Boyle with smooth blades	Size 4	25 x 93 mm	13.5 cm
N26005	Tongue Depressor by Davis-Boyle with smooth blades	Size 5	26 x 108 mm	13.5 cm



Number	Description		Length	
N26102	Tongue Depressor by Davis-Boyle with anaesthetic tube and smooth blades	Size 2	23 x 65 mm	13.5 cm
N26103	Tongue Depressor by Davis-Boyle with anaesthetic tube and smooth blades	Size 3	24 x 80 mm	13.5 cm
N26104	Tongue Depressor by Davis-Boyle with anaesthetic tube and smooth blades	Size 4	25 x 93 mm	13.5 cm
N26105	Tongue Depressor by Davis-Boyle with anaesthetic tube and smooth blades	Size 5	26 x 108 mm	13.5 cm



Number	Description		Length	
N26301	Tongue Depressor by Davis-Boyle for Children with smooth blades	Size 1	17 x 30 mm	9.8 cm
N26302	Tongue Depressor by Davis-Boyle for Children with smooth blades	Size 2	19 x 45 mm	9.8 cm
N26303	Tongue Depressor by Davis-Boyle for Children with smooth blades	Size 3	20 x 60 mm	9.8 cm
N26304	Tongue Depressor by Davis-Boyle for Children with smooth blades	Size 4	22 x 70 mm	9.8 cm
N26305	Tongue Depressor by Davis-Boyle for Children with smooth blades	Size 5	22 x 80 mm	9.8 cm



MCIVOR MOUTH GAG

- Stainless Steel

Number	Description
N25000	Frame for Mouth Gag by Mclvor for use with tongue depressors N25001 - N25003

Number	Description	Size	Rod Length
N25001	Tongue Depressor by Mclvor	Size 1	23 x 70 mm
N25002	Tongue Depressor by Mclvor	Size 2	25 x 86 mm
N25003	Tongue Depressor by Mclvor	Size 3	26 x 100 mm

KILNER-DOUGHTY MOUTH GAG

- Stainless Steel

Number	Description
N27000	Left frame for Mouth Gag by Kilner-Doughty
N27010	Palate Support for toothless patients for N27000

RUSSEL-DAVIS MOUTH TONGUE DEPRESSOR

- Stainless Steel

Number	Description	Size	Length
N27001	Tongue Depressor by Russel-Davis with central channel	Size 1	28 x 65 mm
N27002	Tongue Depressor by Russel-Davis with central channel	Size 2	32 x 72 mm
N27003	Tongue Depressor by Russel-Davis with central channel	Size 3	37 x 80 mm
N27004	Tongue Depressor by Russel-Davis with central channel	Size 4	41 x 94 mm
N27005	Tongue Depressor by Russel-Davis with central channel	Size 5	46 x 103 mm

Number	Description	Size	Length
N28601	Tongue Depressor by Russel-Davis with central channel and lateral outlet	Size 1	28 x 65 mm
N28602	Tongue Depressor by Russel-Davis with central channel and lateral outlet	Size 2	32 x 72 mm
N28603	Tongue Depressor by Russel-Davis with central channel and lateral outlet	Size 3	37 x 80 mm
N28604	Tongue Depressor by Russel-Davis with central channel and lateral outlet	Size 4	41 x 94 mm
N28605	Tongue Depressor by Russel-Davis with central channel and lateral outlet	Size 5	46 x 103 mm



WUERZBURG MODEL TONGUE DEPRESSOR

- Stainless Steel

Number	Description		
N28001	Wuerzburg Model Tongue Depressor	Size 1	28 x 66 mm
N28002	Wuerzburg Model Tongue Depressor	Size 2	32 x 75 mm
N28003	Wuerzburg Model Tongue Depressor	Size 3	34 x 83 mm
N28004	Wuerzburg Model Tongue Depressor	Size 4	37 x 93 mm
N28005	Wuerzburg Model Tongue Depressor	Size 5	38 x 100 mm



RING TONGUE DEPRESSOR

- Stainless Steel

Number	Description		
N28202	Left Ring Tongue Depressor	Size 2	23 x 58 mm
N28302	Right Ring Tongue Depressor		
N28203	Left Ring Tongue Depressor	Size 3	27 x 72 mm
N28303	Right Ring Tongue Depressor		
N28204	Left Ring Tongue Depressor	Size 4	34 x 87 mm
N28304	Right Ring Tongue Depressor		
N28205	Left Ring Tongue Depressor	Size 5	37 x 95 mm
N28305	Right Ring Tongue Depressor		



DAVIS-MEYER TONGUE DEPRESSOR

- Stainless Steel

Number	Description		
N28401	Tongue Depressor by Davis-Meyer with anesthetic tubes on both sides	Size 1	29.0 x 70 mm
N28402	Tongue Depressor by Davis-Meyer with anesthetic tubes on both sides	Size 2	30.5 x 75 mm
N28403	Tongue Depressor by Davis-Meyer with anesthetic tubes on both sides	Size 3	31.5 x 80 mm
N28404	Tongue Depressor by Davis-Meyer with anesthetic tubes on both sides	Size 4	32.5 x 85 mm
N28405	Tongue Depressor by Davis-Meyer with anesthetic tubes on both sides	Size 5	33.5 x 95 mm
N28406	Tongue Depressor by Davis-Meyer with anesthetic tubes on both sides	Size 6	33.8 x 100 mm
N28407	Tongue Depressor by Davis-Meyer with anesthetic tubes on both sides	Size 7	34.0 x 105 mm



DRAFFIN SUSPENSION APPARATUS BIPOD

Number	Description
N24820	Suspension Apparatus Bipod by Draffin for use with Mouth Gags N25000 - N28400
N24810	Chain with ring to suspend the mouth gag at the frame N24880

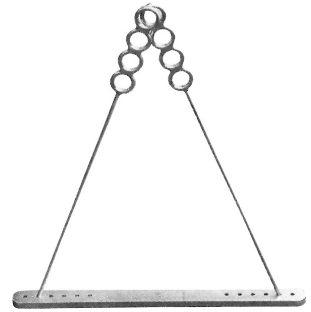
NEGUS CHEST SUPPORT

Number	Description		Rod Length
N29000	Chest Support by Negus with band N29001	Adult Size	14 cm
N29100	Chest Support by Negus with band N29001	Child Size	8.5 cm
N29001	Chest Support by Negus with band only for N29000 & N29100		13 cm

WUERZURG CHEST SUPPORT

Number	Description
N29200	Chest Support by Wuerzburg

TOOTH GUARD

Number	Description			Diameter
N20410	Wooden Tooth Guard	Pyramid Shaped	Serrated	40 mm



Number	Description			Diameter
N20420	Latex Tooth Guard	Pyramid Shaped	Serrated	40 mm



Number	Description		Diameter
N20450	Latex Tooth Guard with Supply Chain	Grooved	40 mm



MCKESSON MOUTH PROP

• Set of 2

Number	Description		
N21001	Silicone Mouth Prop with airway	Serrated	Small child
N21002	Silicone Mouth Prop with airway	Serrated	Child
N21003	Silicone Mouth Prop with airway	Serrated	Adult

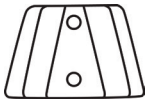

N21001



N21002

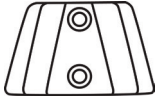

N21003



OBWEGESER RETRACTOR

Number	Description		Length
L20217	Obwegeser Cheek Retractor	Stainless Steel	10 cm

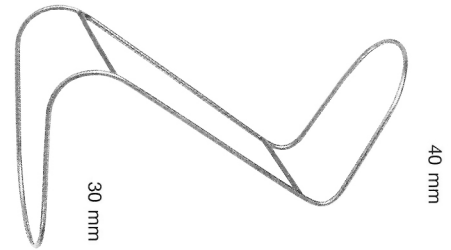
UNIVERSITY OF MINNESOTA RETRACTOR

Number	Description		Length
L20210	University of Minnesota Tongue and Cheek Retractor	Stainless Steel	14 cm

STERNBERG RETRACTOR

Number	Description		Length
L20215	Sternberg Cheek, Lip and Tongue Retractor	Stainless Steel	14.5 cm

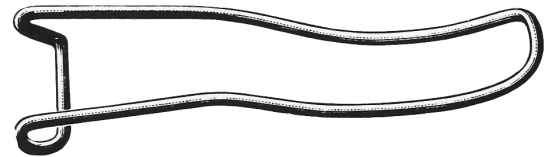
SHUMAN RETRACTOR

Number	Description		Length
L20225	Shuman Cheek and Tongue Retractor	Stainless Steel	19 cm

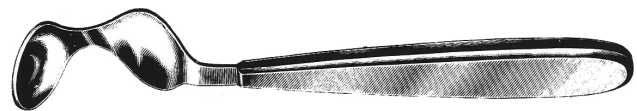
RING RETRACTOR

Number	Description	
L20245	Cheek Ring Retractor	Stainless Steel

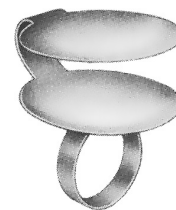

LOVE UVULA RETRACTOR

• Stainless Steel

Number	Description	Width	Working Length
N16318	Love Uvula Retractor	18 mm	15 cm
N16320	Love Uvula Retractor	20 mm	15 cm
N16322	Love Uvula Retractor	22 mm	15 cm

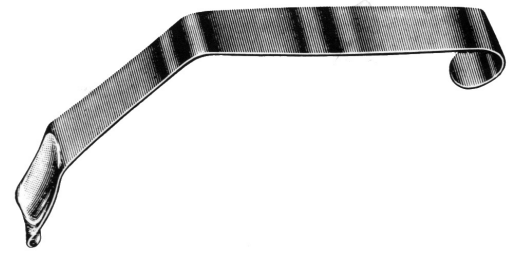

GOODYEAR UVULA RETRACTOR

• Stainless Steel

Number	Description	Width	Working Length
N16348	Goodyear Uvula Retractor	27 mm	9.5 cm

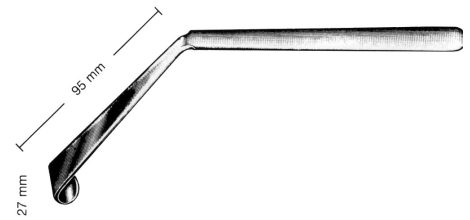

LOTHROP UVULA RETRACTOR

• Stainless Steel

Number	Description	Width	Working Length
N16360	Lothrop Uvula Retractor	18 mm	18 cm

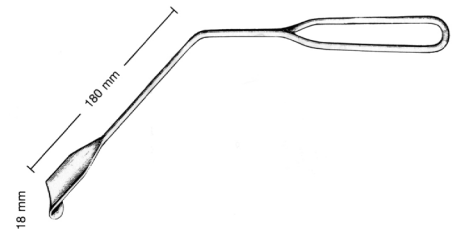

NAGER SOFT PALATE RETRACTOR

• Stainless Steel

Number	Description	Width	Working Length
N16423	Nager Uvula Retractor	13 mm	22 cm

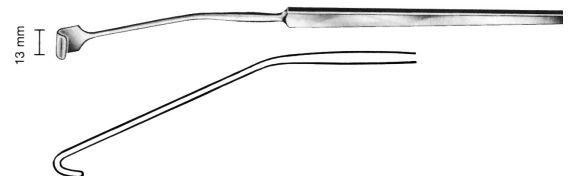

HOFER PALATE ARCH RETRACTOR

• Stainless Steel

Number	Description	Width	Working Length
N16474	Hofer Palate Arch Retractor	20 x 20 mm	24 cm

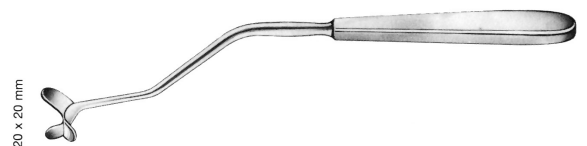

HASLINGER SOFT PALATE RETRACTOR

- Stainless Steel

Number	Description	Working Length
N16520	Haslinger Soft Palate Retractor	17 cm

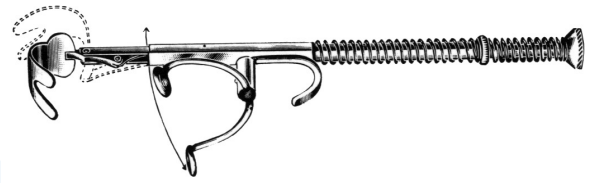

YANKAUER NASO-PHARYNGEAL SPECULUM RETRACTOR

Number	Description
N16570	Yankauer Naso-Pharyngeal Speculum Retractor

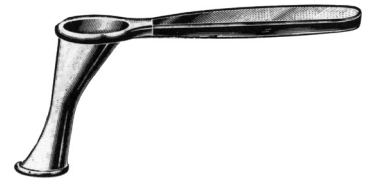

TONGUE SPATULA

• Stainless Steel

Number	Description	Width	Working Length
N20010	Tongue Spatula	18 mm	14.5 cm

18 mm

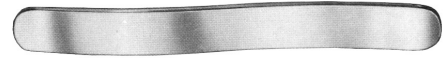

Number	Description	Width	Working Length
N20015	Tongue Spatula	20 mm / 23 mm	14 cm

20 mm

23 mm



BAGINSKI TONGUE SPATULA

• Stainless Steel

Number	Description	Width	Working Length
N20005	Baginski Tongue Spatula	18 mm / 35 mm	15 cm

18 mm

35 mm

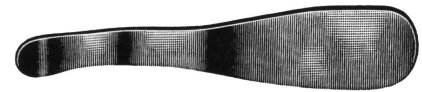

BUCHWALD TONGUE SPATULA

• Stainless Steel

Number	Description	Width	Working Length
N20018	Buchwald Tongue Spatula	18 mm / 23 mm	18 cm

18 mm

23 mm



HASLINGER TONGUE SPATULA

• Stainless Steel

Number	Description	Width	Working Length
N20027	Haslinger Tongue Spatula	22 mm / 29 mm	12 cm
N20028	Haslinger Tongue Spatula	30 mm / 33 mm	16 cm

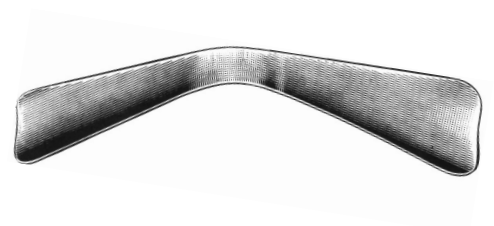

FRENZEL TONGUE SPATULA

- Stainless Steel

Number	Description	Width	Working Length
N20035	Frenzel Tongue Spatula	23 mm / 13 mm	16.5 cm

BRÜNING'S TONGUE SPATULA

- Stainless Steel

Number	Description	Width	Working Length
N20050	Brünings Tongue Spatula	18 mm / 14 mm	19 cm

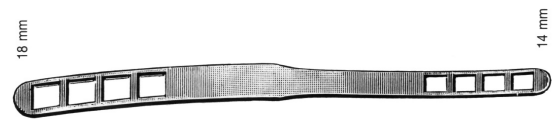
MORITZ-SCHMIDT TONGUE SPATULA

- Stainless Steel

Number	Description	Working Length
N20085	Moritz-Schmidt Tongue Spatula	19 cm

ANDREWS TONGUE SPATULA

- Stainless Steel

Number	Description	Width	Working Length
N20130	Andrews Tongue Spatula	17 mm	8.5 cm

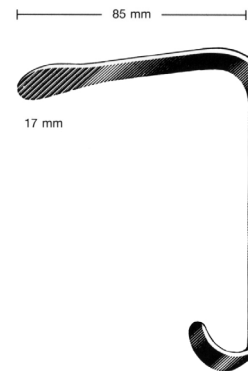
WIEDER TONGUE SPATULA

- Stainless Steel

Number	Description	Width	Working Length
N20140	Wieder Tongue Spatula	28 mm	8 cm
N20141	Wieder Tongue Spatula	38 mm	8 cm

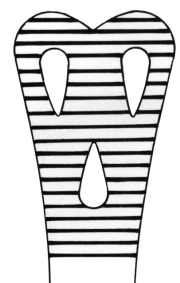
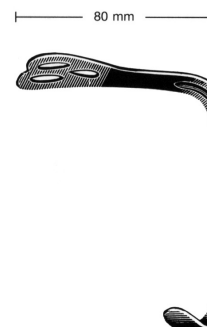

BOSWORTH TONGUE SPATULA

• Stainless Steel

Number	Description	Width	Working Length
N20110	Bosworth Tongue Spatula	25 mm	8 cm

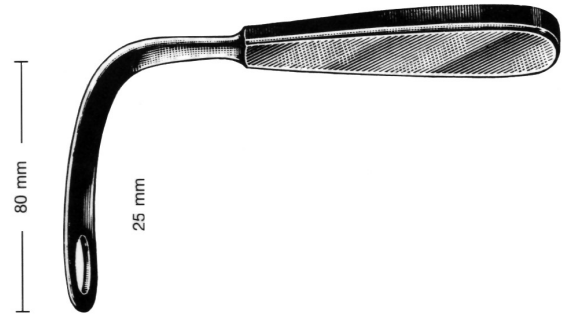

TOBOLD TONGUE SPATULA

• Stainless Steel

Number	Description	Width	Working Length
N20115	Tobold Tongue Spatula	25 mm	8 cm

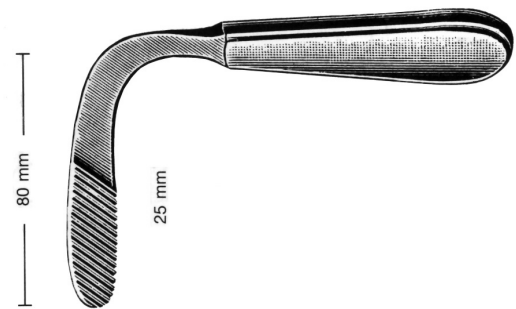

HARTMANN TONGUE SPATULA

• Stainless Steel

Number	Description	Width	Working Length
N20125	Hartmann Tongue Spatula	23 mm	7.5 cm

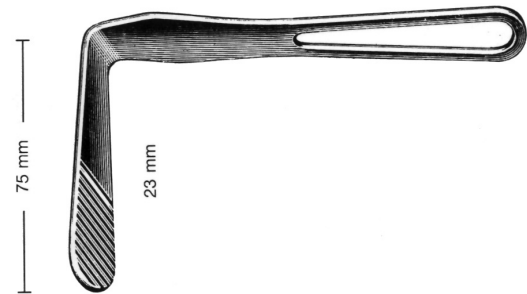

FINGER GUARD

• Stainless Steel

Number	Description	Diameter
N20101	Finger Guard #1	17 - 21 mm
N20102	Finger Guard #2	19 - 24 mm
N20103	Finger Guard #3	21 - 26 mm

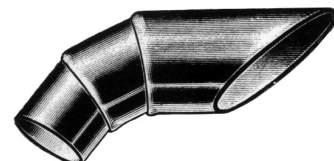

RONIS BIOPSY FORCEPS

• Stainless Steel

Number	Description		Size	Working Length
N02201	Biopsy forceps by Ronis	Upturned with triangular basket	1 = 7 mm	130 mm
M02202	Biopsy forceps by Ronis	Upturned with triangular asket	2 = 8 mm	130 mm

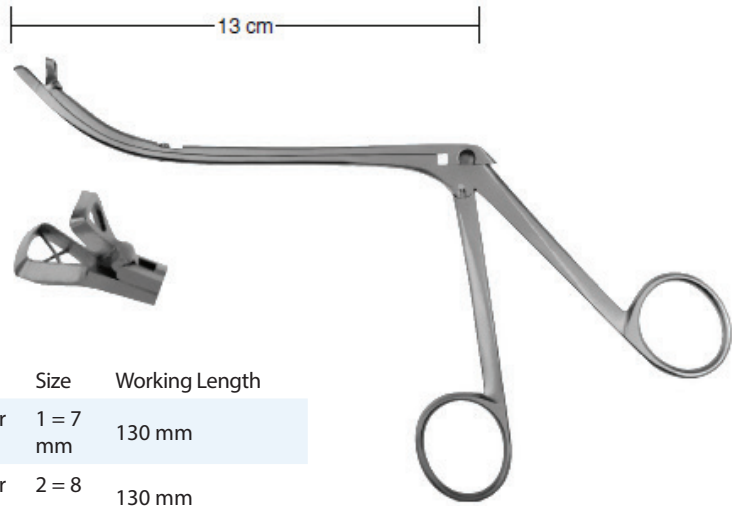

MELTZER ADENOID PUNCH

• Stainless Steel

Number	Description		Size	Working Length
N02300	Adenoid punch by Meltzer	Straight with triangular basket	0 = 6 mm	140 mm
N02301	Adenoid punch by Meltzer	Straight with triangular basket	1 = 7 mm	140 mm
N02302	Adenoid punch by Meltzer	Straight with triangular basket	2 = 8 mm	140 mm
N02303	Adenoid punch by Meltzer	Straight with triangular basket	3 = 10 mm	140 mm

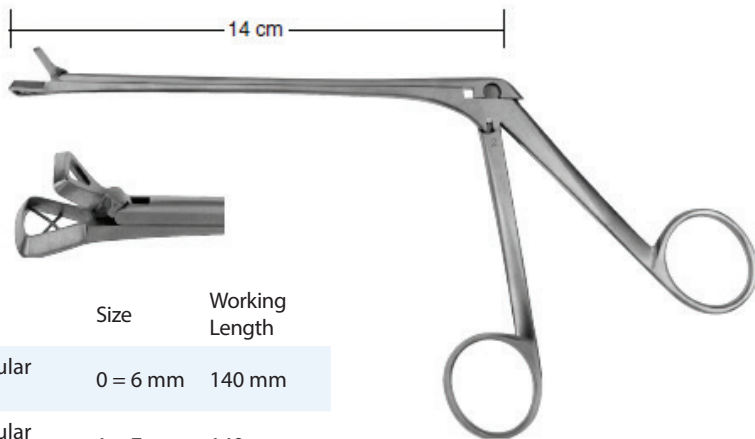

MELTZER ADENOID PUNCH

• Stainless Steel

Number	Description		Size	Working Length
N02311	Adenoid punch by Meltzer	Straight with round basket	1 = 7 mm	140 mm
N02312	Adenoid punch by Meltzer	Straight with round basket	2 = 8 mm	140 mm

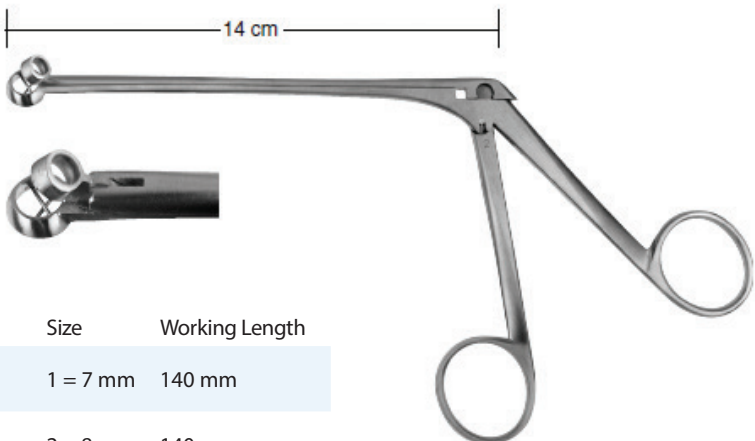

NASO-PHARYNGEAL BIOPSY FORCEPS

• Stainless Steel

Number	Description	
N15062	Naso-pharyngeal biopsy forceps with malleable tip	Jaws open to the right
N15063	Naso-pharyngeal biopsy forceps with malleable tip	Jaws open to the left

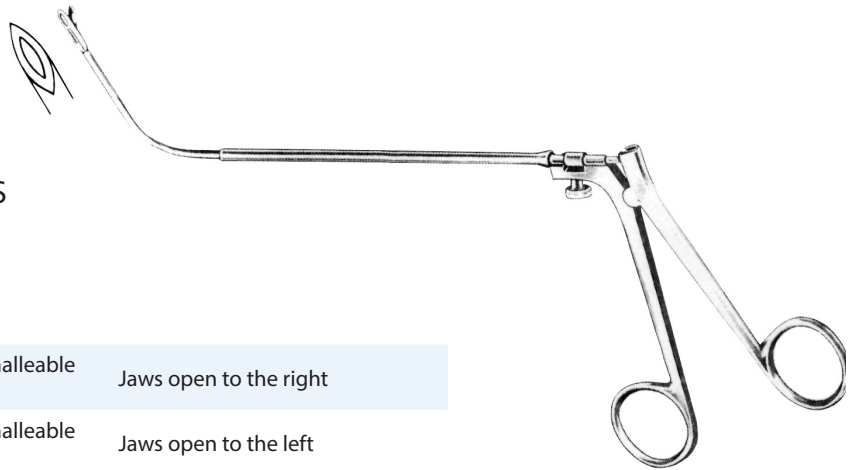

HARTMANN ADENOID PUNCH

• Stainless Steel

Number	Description		Working Length
N15212	Hartmann adenoid punch with basket	Round	16.5 cm

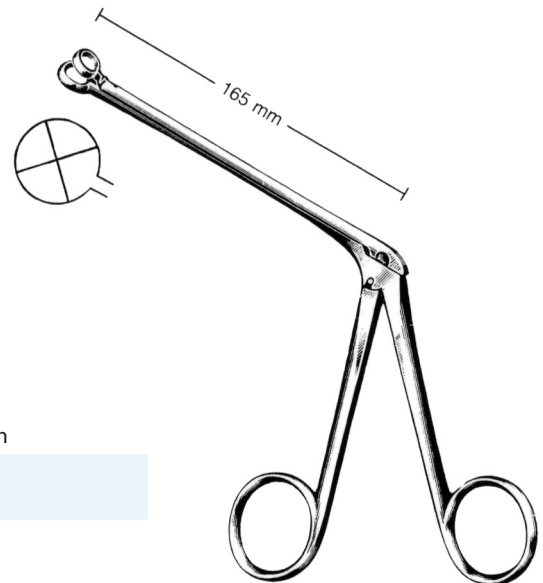

SCHMEDEN ADENOID PUNCH

• Stainless Steel

Number	Description		Working Length
N15212	Shemedan adenoid punch with basket	Triangular	16.5 cm

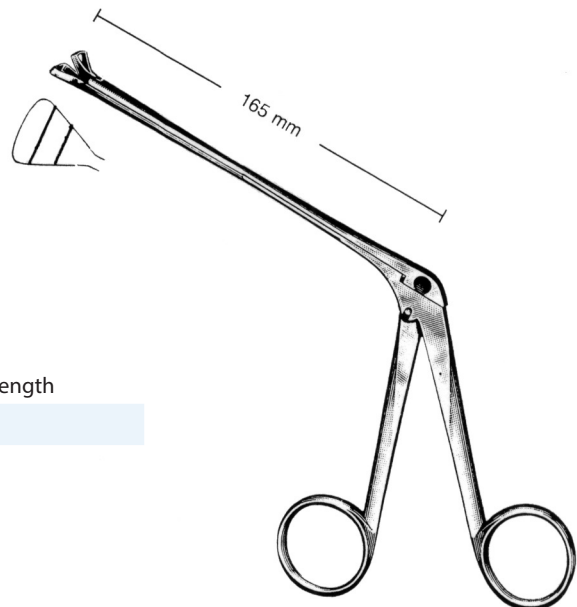

ST. CLAIR-THOMSON NASO-PHARYNGEAL FORCEPS

- Stainless Steel

Number	Description		Working Length
N15018	St. Clair-Thomson Naso-Pharyngeal forceps	sharp	18 cm

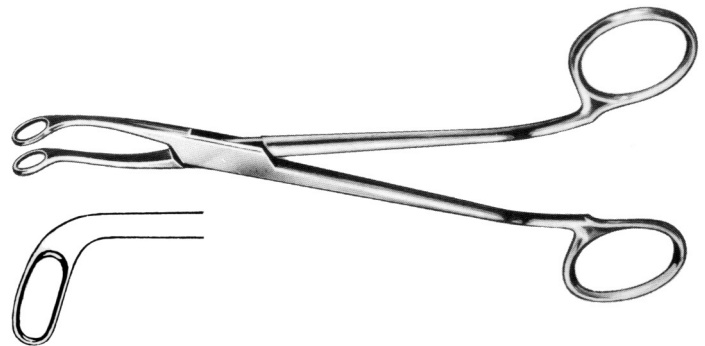
JURASZ NASO-PHARYNGEAL FORCEPS

- Stainless Steel

Number	Description		Working Length
N15019	Jurasz Naso-Pharyngeal forceps for children	sharp	19 cm

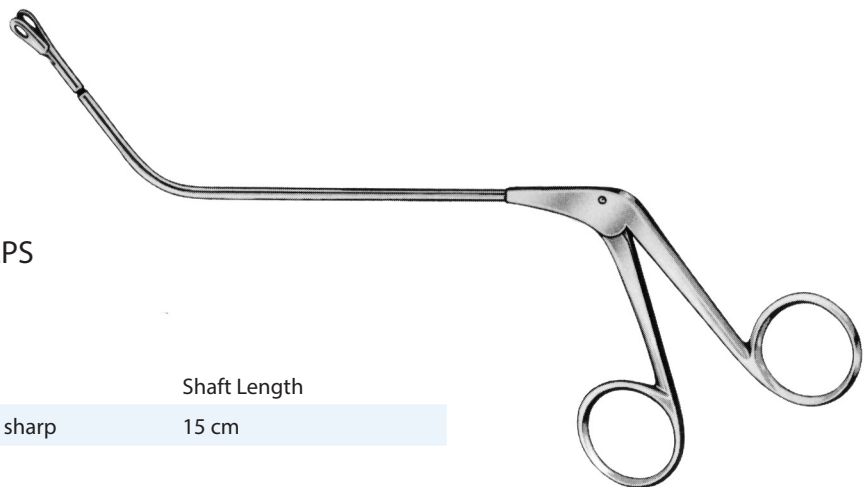
JATHO NASO-PHARYNGEAL FORCEPS

- Stainless Steel

Number	Description		Shaft Length
N15050	Jatho Naso-Pharyngeal forceps	sharp	15 cm

JATHO EPIPHARYNGEAL FORCEPS

• Stainless Steel

Number	Description		Working Length
N01500	Jatho Epipharyngeal forceps with horizontal opening	Upturned with fenestrated cupped jaws	15 cm
N01501	Jatho Epipharyngeal forceps with vertical opening	Upturned with fenestrated cupped jaws	15 cm



FRENZEL CONCHOTOME

• Stainless Steel

Number	Description			Diameter	Working Length
N01600	Frenzel Conchotome for adenotomies	Ring shaped jaws	Upturned	10 mm	14 cm

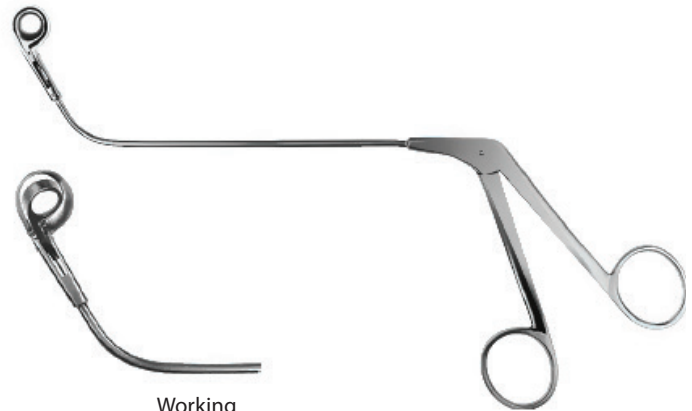

HARTMANN TONSIL PUNCH

• Stainless Steel

Number	Description		Diameter	Working Length
N26513	Hartmann tonsil punch	Sharp	13 mm	12 cm
N26515	Hartmann tonsil punch	Sharp	15 mm	12 cm
N26517	Hartmann tonsil punch	Sharp	17 mm	12 cm

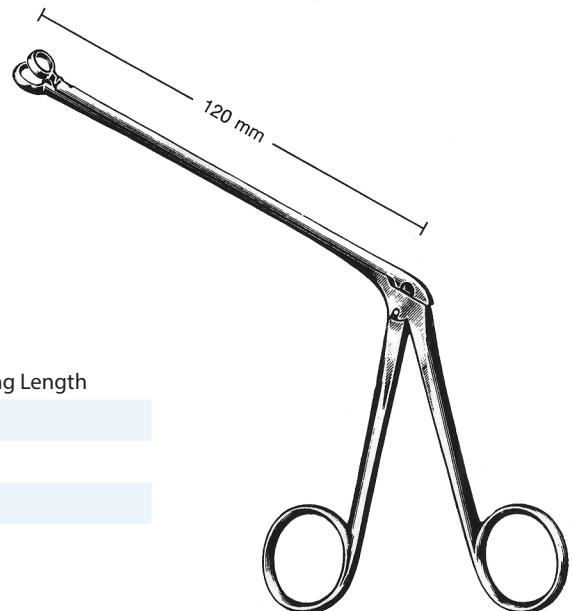

NEGUS TONSIL ARTERY CLAMP

• Stainless Steel

Number	Description	Size	Working Length
N24221	Negus tonsil artery clamp	1	19 cm
N24222	Negus tonsil artery Clamp with long curve	2	19 cm

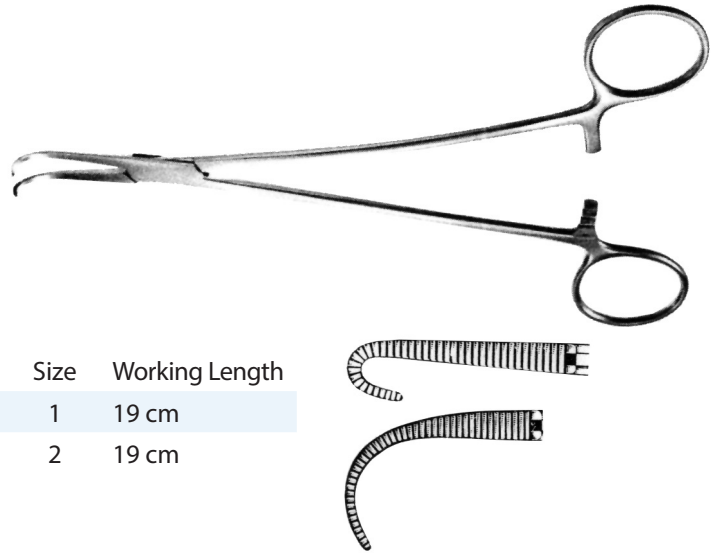
MUCK TONSIL ARTERY CLAMP

• Stainless Steel

Number	Description	Size	Tip	Working Length
N24281	Muck tonsil clamp	1	8 mm	18 cm
N24282	Muck tonsil clamp	2	10 mm	18 cm

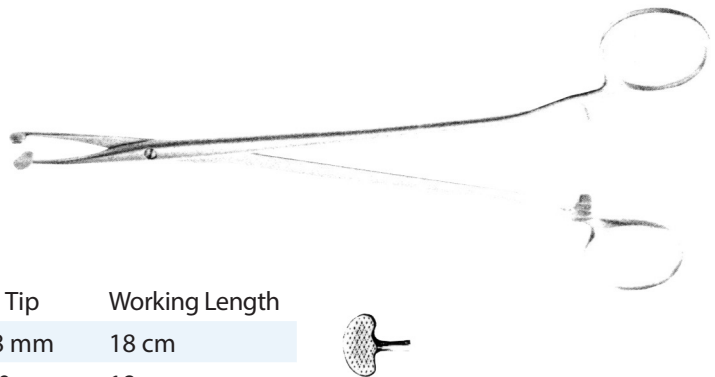
MCWORTHER-LOTHROP TONSIL ARTERY CLAMP

• Stainless Steel

Number	Description	Working Length
N24290	McWorther-Lothrop tonsil artery clamp	18.5 cm

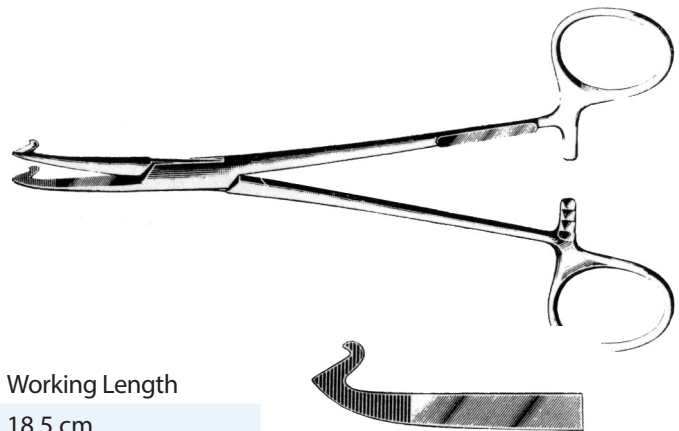



HEISS-BIRKETT TONSIL ARTERY CLAMP

• Stainless Steel

Number	Description			Working Length
N50000	Heiss-Birkett tonsil artery clamp	Straight	Slender	20 cm
N50100	Heiss-Birkett tonsil artery clamp	Slightly curved	Slender	20 cm



SCHNIDT TONSIL ARTERY CLAMP

• Stainless Steel

Number	Description			Working Length
N51000	Schnidt tonsil artery clamp	Slightly curved	Slender	19 cm
N51100	Schnidt tonsil artery clamp	Strong curved	Slender	19 cm

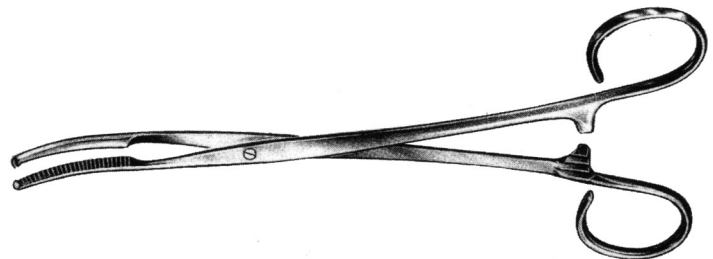

MIKULICZ TONSIL ARTERY CLAMP

• Stainless Steel

Number	Description	Working Length
N24015	Mikulicz tonsil artery clamp	18 cm

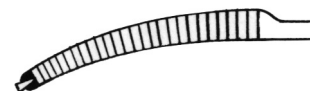

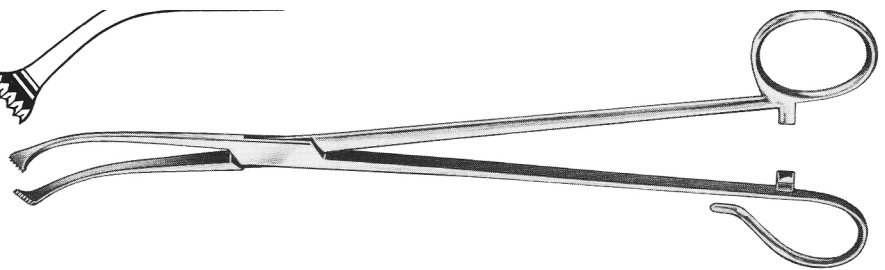

MARSCHIK TONSIL FORCEPS

Number	Description	Working Length
N24005	Tonsil forceps by Marschik	22 cm

WHITE TONSIL SEIZING FORCEPS

- Stainless Steel
- Open ring

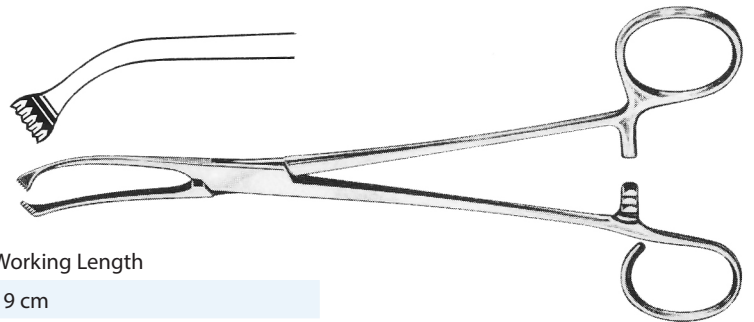
Number	Description	Working Length
N24018	Tonsil seizing forceps by White	18 cm
N24023	Tonsil seizing forceps by White	23 cm

COLVER TONSIL FORCEPS

Number	Description	Working Length
N24019	Tonsil forceps by Colver	19 cm

BLOHMKE TONSIL SEIZING FORCEPS

- Stainless Steel
- Open ring

Number	Description	Working Length
N24021	Tonsil seizing forceps by Blohmke	21 cm

ABRAHAM TONSIL FORCEPS

- Open ring

Number	Description	Working Length
N24022	Tonsil forceps by Tyding	20.5 cm

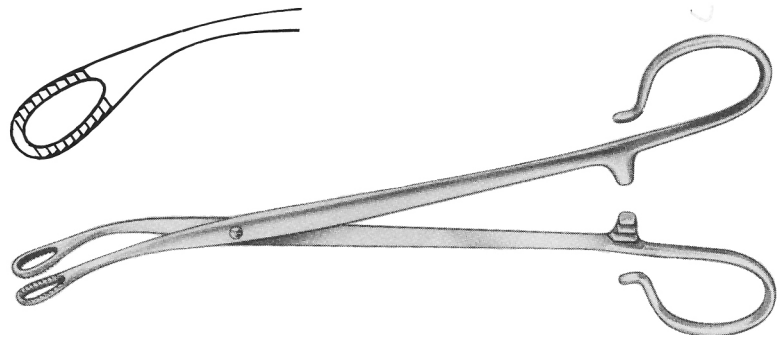

THILENIUS TONSIL ABSCESS FORCEPS

- Stainless Steel

Number	Description	Working Length
N24090	Tonsil seizing forceps by Thilenius	20 cm

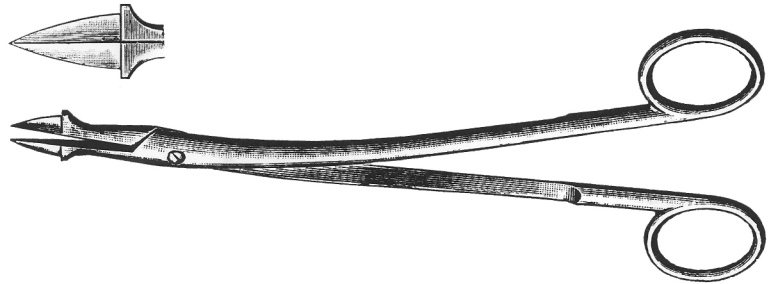

TYDING TONSIL FORCEPS

- Open ring

Number	Description	Working Length
N36000	Tonsil forceps by Tyding 2 x 2 teeth	21 cm



Tivnen Tonsil Forceps

Number	Description	Working Length
N36100	Tonsil forceps by Tivnen 3 x 3 teeth	21 cm





TONSIL KNIVES

Number	Description	Working Length
N22005	Tonsil knife	18 cm

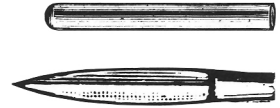

CANFIELD TONSIL KNIVES

Number	Description	Working Length
N22030	Canfield tonsil knife	21 cm



ABRAHAM TONSIL KNIVES

Number	Description	Working Length
N22035	Abraham tonsil knife	21 cm



BRÜNINGS TONSIL KNIVES

Number	Description	Working Length
N22040	Brünings tonsil knife	23 cm



DAY TONSIL KNIVES

Number	Description	Working Length
N22050	Day tonsil knife	23 cm





ABRAHAM (TYDING) TONSIL KNIVES

Number	Description	Working Length
N22055	Abraham (Tyding) tonsil knife	20 cm



FISHER (COLVER) TONSIL KNIVES

Number	Description	Working Length
N22070	Fisher (Colver) tonsil knife	22.5 cm



REVERSIBLE SCREWS

Number	Description	Diameter	Working Length
N22085	Reversible screw	7 mm	21 cm
N22087	Reversible screw	4 mm	10 cm

YANKAUER TONSIL DISSECTORS

- Stainless Steel

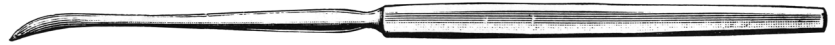

Number	Description	Working Length
N22505	Yankauer tonsil dissector	21 cm

HURD TONSIL DISSECTORS

- Stainless Steel



Number	Description	Size	Working Length
N22515	Hurd tonsil dissector	6 / 12 mm	22 cm
N22520	Hurd tonsil dissector	10 / 12 mm	22 cm

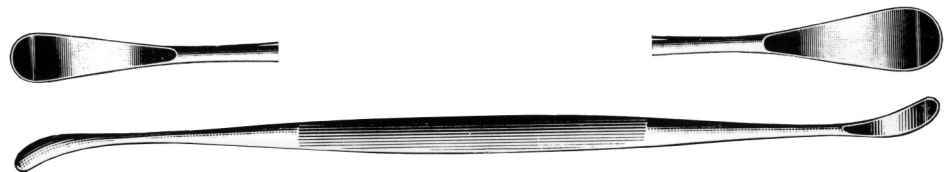

ALDERDICE TONSIL DISSECTORS

- Stainless Steel

Number	Description	Working Length
N22530	Alderdice tonsil dissector	22 cm



HENKE TONSIL DISSECTORS

- Stainless Steel

Number	Description	Size	Working Length
N22535	Henke tonsil dissector	12 / 18 mm	24 cm

HENKE TONSIL DISSECTORS

Number	Description	Size	Working Length
N22537	Henke tonsil dissector	12 mm	23 cm
N22538	Henke tonsil dissector	17 mm	23 cm

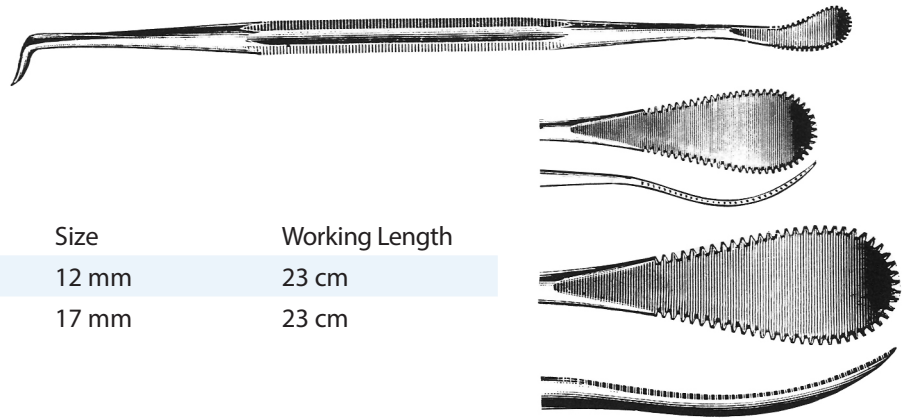

LOPEZ-REINKE TONSIL DISSECTORS

Number	Description	Working Length
N02540	Lopez-Reinke tonsil dissector with suction device	23 cm

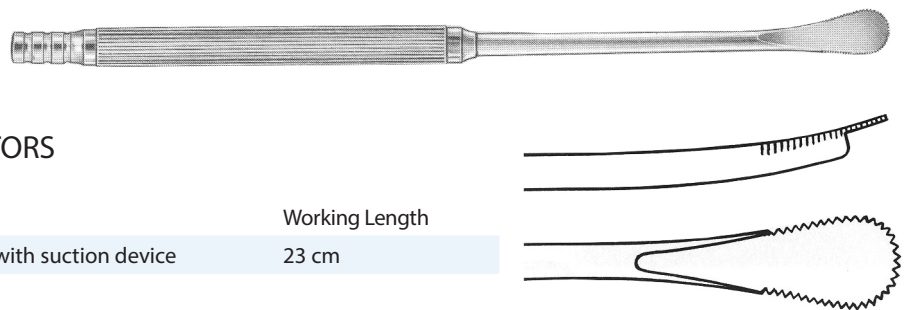

CARPENTER TONSIL DISSECTORS

Number	Description	Working Length
N02540	Carpenter tonsil dissector	25 cm

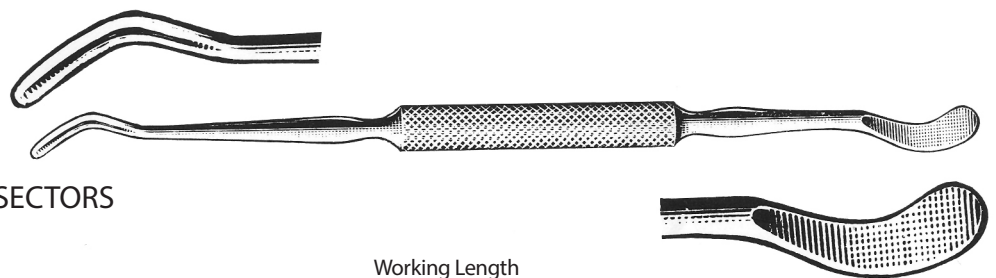

METZENBAUM TONSIL SCISSORS

• Stainless Steel



Number	Description		Working Length
N42018	Tonsil Scissors by Metzenbaum	Curved	18 cm
N42020	Tonsil Scissors by Metzenbaum	Curved	20 cm
N42218	Tonsil Scissors by Metzenbaum with tungsten carbide tip and gold handles	Curved	18 cm
N42220	Tonsil Scissors by Metzenbaum with tungsten carbide tip and gold handles	Curved	20.5 cm

LILLY TONSIL SCISSORS

• Stainless Steel



Number	Description		Working Length
N41400	Tonsil Scissors by Lilly	Curved	19 cm

PRINCE TONSIL SCISSORS

• Stainless Steel

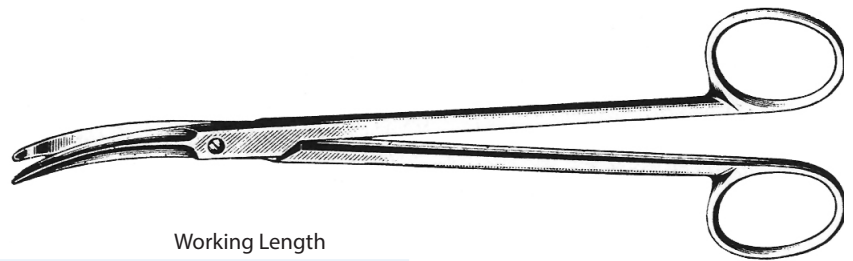

Number	Description		Working Length
N24520	Tonsil Scissors by Prince		18 cm

BOETTCHER TONSIL SCISSORS

• Stainless Steel

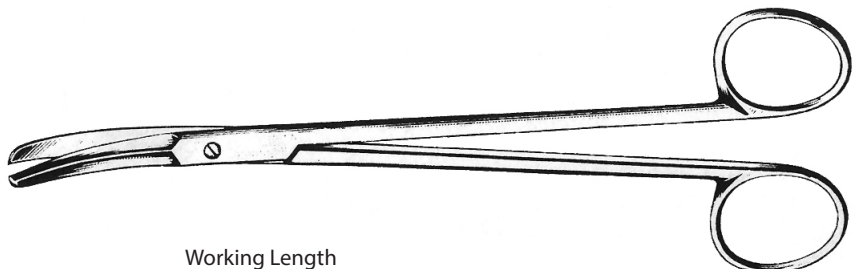

Number	Description		Working Length
N24525	Tonsil Scissors by Boettcher		18 cm

GOOD TONSIL SCISSORS

- Stainless Steel

Number	Description	Working Length
N24530	Tonsil Scissors by Good	19 cm

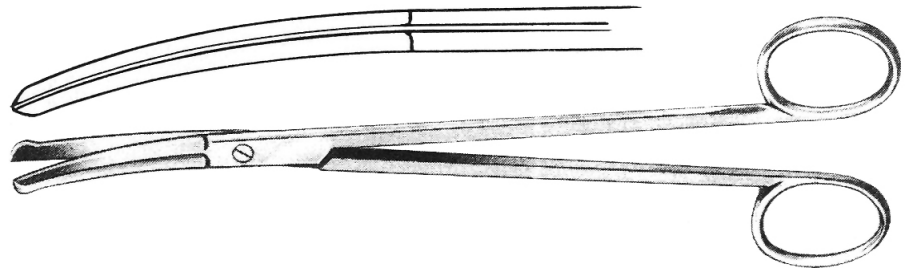

DEAN TONSIL SCISSORS

- Stainless Steel

Number	Description	Working Length
N24550	Tonsil Scissors by Dean 1 serrated blade	17 cm

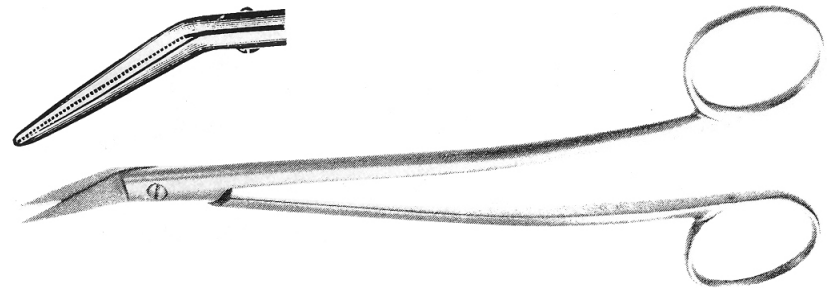

BRÜNINGS TONSIL SNARE

• Stainless Steel

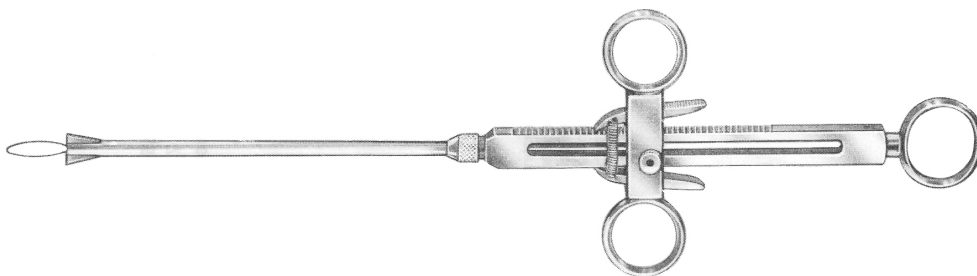

Number	Description	Working Length
N25005	Tonsil snare with catch with Brünings Includes 3 wire loops	29 cm

EVES TONSIL SNARE

• Stainless Steel

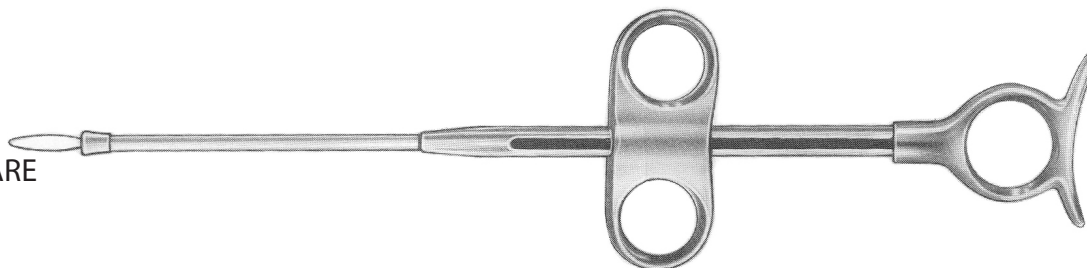

Number	Description	Working Length
N25010	Tonsil snare by Eves Includes 3 preshaped wires	27 cm

EVES TONSIL SNARE

• Stainless Steel

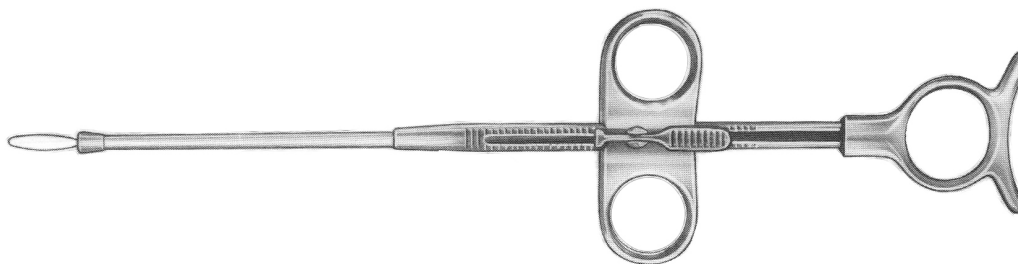

Number	Description	Working Length
N25011	Tonsil snare with catch by Eves	27 cm

LEWIS TONSIL SNARE

• Stainless Steel

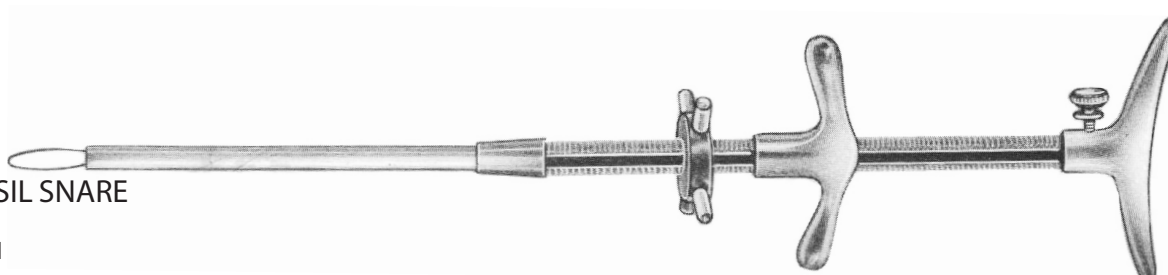

Number	Description	Working Length
N25016	Tonsil snare by Lewis Includes 3 preshaped wires	25.5 cm

ROEDER "E" TONSIL SNARE

• Stainless Steel

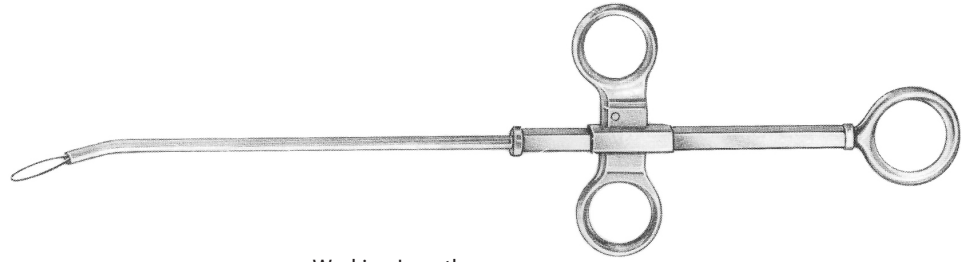

Number	Description	Working Length
N25025	Tonsil snare by Roeder "E" for catgut suture	27 cm

TYDING TONSIL SNARE

• Stainless Steel

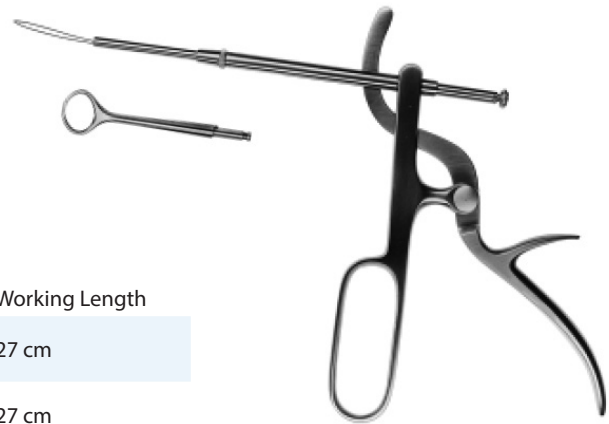

Number	Description	Working Length
N25051	Tonsil Snare by Tyding with 3 preshaped wires Straight tip	27 cm
N25052	Tonsil Snare by Tyding with 3 preshaped wires Straight, Vedder looped tip	27 cm
N25053	Straight tip only	
N25054	Vedder loop tip only	

TONSIL SNARE WIRE LOOPS

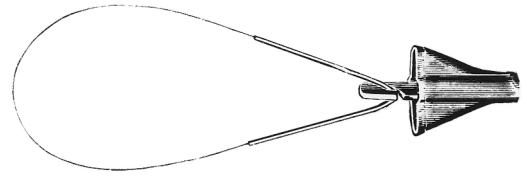

Number	Description	
N25095	Soldered tonsil snare wire loops	100 / pack

TONSIL SNARE PRE-CUT WIRE



Number	Description	Diameter
N25096	Pre-cut wire for tonsil snares	.35 mm
N25097	Pre-cut wire for tonsil snares (Standard Size)	.40 mm
N25098	Pre-cut wire for tonsil snares	.45 mm
N25099	Pre-cut wire for tonsil snares	.50 mm

SNARE WIRES

Number	Description		Diameter
N61543	Wire for snare	10 m coil	.35 mm
N61544	Wire for snare	10 m coil	.40 mm
N61545	Wire for snare	10 m coil	.45 mm

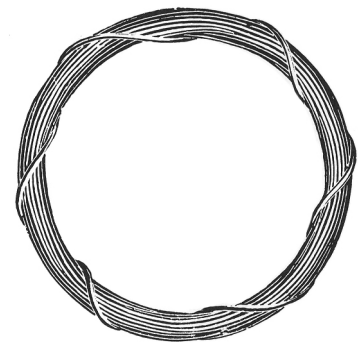

SNARE CATGUT SUTURE LOOPS

Number	Description		
N25025	Catgut suture loops for snares	Sterile	20 / box
N25030	Catgut suture loops for snares Thickness 0	Sterile	20 / box
N25031	Catgut suture loops for snares Thickness 1	Sterile	20 / box

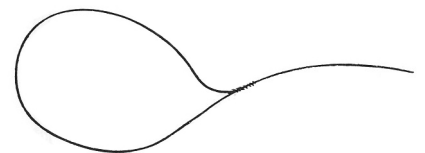

SLUDER-BALLENGER TONSILTOME

- Stainless Steel handle

Number	Description
N26010	Tonsiltome by Sluder-Ballenger, complete with one blade of each size #1-3 Angled-up blades
N26019	Handle only for tonsiltome by Sluder-Ballenger



SLUDER-BALLENGER TONSILTOME BLADES

Number	Description	Size	width
N26021	Blades for tonsiltome by Sluder-Ballenger	1	18 mm
N26022	Blades for tonsiltome by Sluder-Ballenger	2	20 mm
N26023	Blades for tonsiltome by Sluder-Ballenger	2	23 mm

ROEDER LOOP APPLICATOR

- Stainless Steel



Number	Description	Type	Overall Length
N46400	Loop applicator by Roeder	Type E	27 cm

NAGER TONSIL SUTURE NEEDLE

- Stainless Steel



Number	Description	Overall Length
N46500	Tonsil suture needle by Nager	24 cm

HURD TONSIL SUTURE NEEDLE

- Stainless Steel



Number	Description	Hand	Overall Length
N46700	Tonsil Suture Needle by Hurd	Right hand	22.5 cm
N46800	Tonsil Suture Needle by Hurd	Left hand	22.5 cm

SUTURE HOOK

- Stainless Steel



Number	Description	Hand	Overall Length
N46900	Suture Hook	Right hand	20.5 cm



KNOTTIER

- Stainless Steel

Number	Description	Overall Length
N47100	Knot tier Fork shaped, blunt	20.5 cm

LUNIATSCHEK TONSIL GAUZE PACKERS

- Stainless Steel



Number	Description	Overall Length
N43700	Tonsil gauze packers by Luniatschek	19 cm

ABRAHAM TONSIL KNIFE

- Stainless Steel



Number	Description	Overall Length
N48000	Tonsil knife by Abraham	21 cm

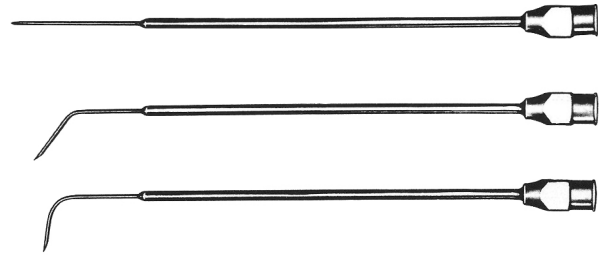

TONSIL SEPTAL CANNULAS WITH LUER-LOCK HUB

• Stainless Steel

Number	Description		Diameter	Length
L29510	Tonsil Cannulas with Luer-Lock Hub	Straight	0.8 mm (22 g)	75 / 25 mm
L29514	Tonsil Cannulas with Luer-Lock Hub	Knee bent, 45°	0.8 mm (22 g)	75 / 25 mm
L29519	Tonsil Cannulas with Luer-Lock Hub	Curved, 90°	0.8 mm (22 g)	75 / 25 mm

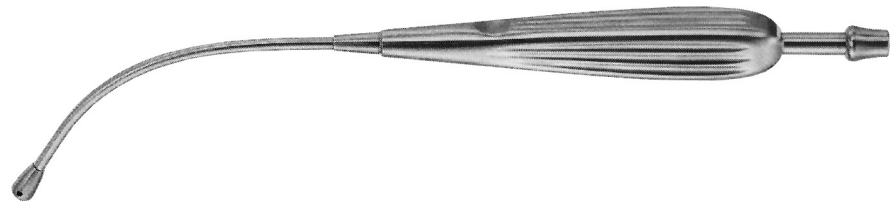
ANDREW PYNCHON PEDIATRIC SUCTION TUBES

Number	Description	Diameter	Length
N506-0421	Andrew Pynchon pediatric suction tubes, tip with lateral holes	3 mm	24 cm
N506-0422	Andrew Pynchon pediatric suction tubes, tip with lateral holes	4.2 mm	24 cm
N506-0424	Andrew Pynchon pediatric suction tubes, tip with lateral holes	6 mm	24 cm

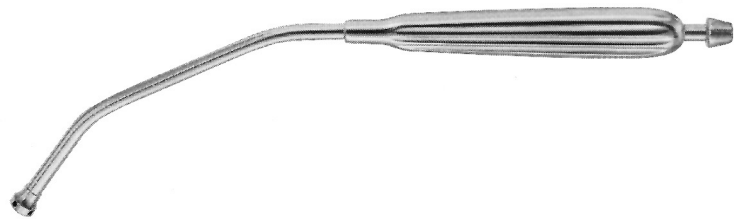
YANKAUER PEDIATRIC SUCTION TUBE

Number	Description	Diameter	Length
N506-0303	Yankauer pediatric suction tube with tube olive	3.5 mm	22 cm

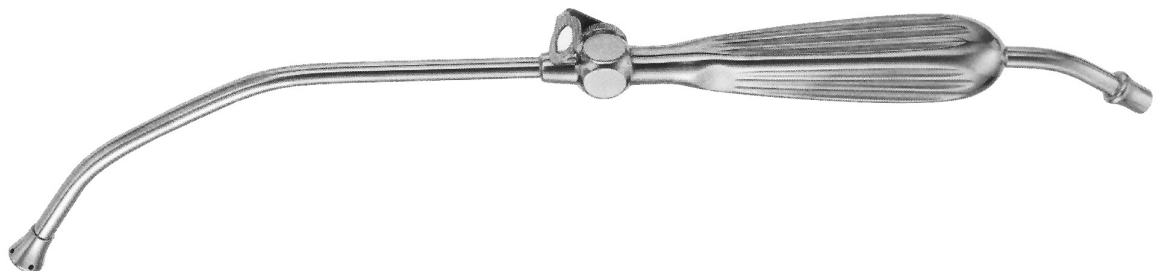

WALTON YANKAUER SUCTION TUBE

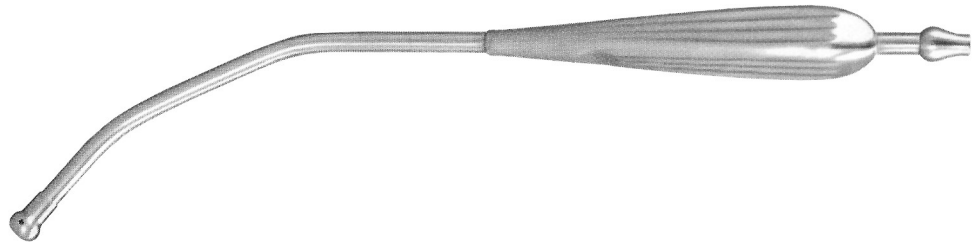
Number	Description	Length
N506-0304	Walton Yankauer suction tube regulating valve with tube olive	32 cm

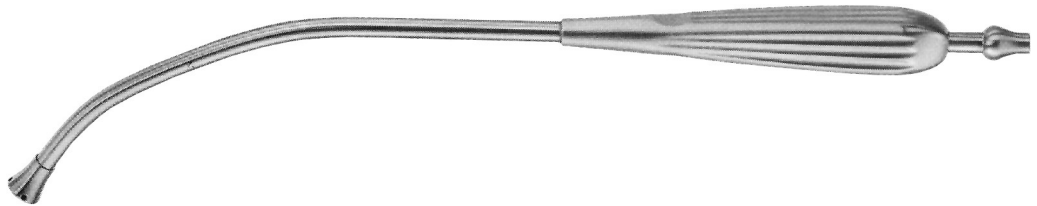

YANKAUER ROUND-TIP SUCTION TUBE

Number	Description	Length
N506-0306	Yankauer suction tube with round suction tip, tube olive	23 cm



YANKAUER SUCTION TUBE

Number	Description	Central bore Ø	Length
N506-0300	Yankauer suction tube with tube olive without light guide	2 mm	28.5 cm
N506-0301	Yankauer suction tube with tube olive without light guide	4.8 mm	28.5 cm
N506-0308	Yankauer suction tube with tube olive with light guide	2 mm	28.5 cm

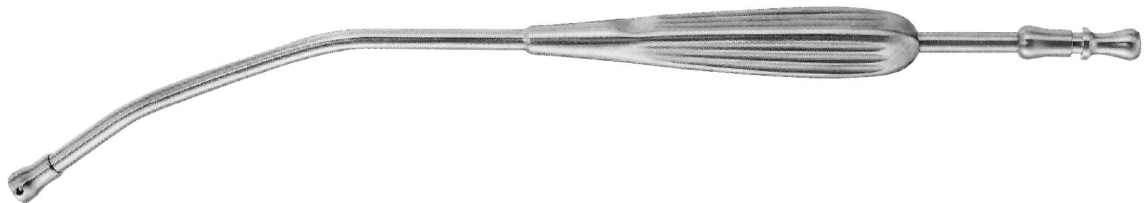

Number	Description	Length
N506-0302	Yankauer suction tube with wall suction extension and tube olive	31 cm
N506-03214	Yankauer suction tube with wall suction extension and tube olive	35.5 cm
N506-03216	Yankauer suction tube with wall suction extension and tube olive	40.5 cm
N506-03218	Yankauer suction tube with wall suction extension and tube olive	45.5 cm

VETTER TONSIL COMPRESSOR

- Stainless Steel

Number	Description
N22595	Vetter Tonsil Compressor

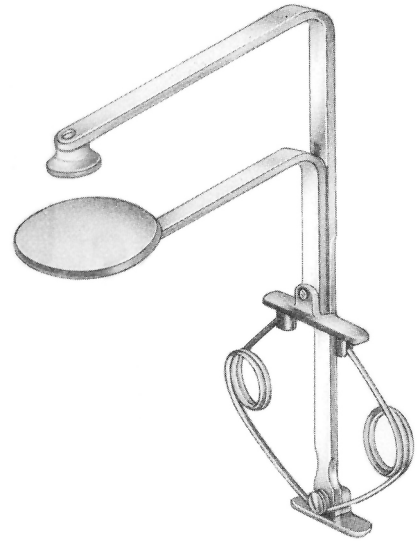

LUNIATSCHECK TONSIL GAUZE PACKER

- Stainless Steel

Number	Description	Working Length
N22595	Luniatscheck Tonsil Gauze Packer	18 cm





CRYOIQ ©
GAS CARTRIDGES

DEVICES

CryoIQ PRO Aesthetic devices

PRO A - Devices with exchangeable tip and gas cartridge with valve

Catalog No.	Description	Package Size
CIQ-PS-L/D2	New! CryoIQ PRO D2 device with 1 standard tip 60 µm, L=10 mm, spray freezing Ø1-6 mm 1 dermatology tip D2, L=22 mm, spray freezing Ø7-18 mm 1 PRO body with lever 1 gas cartridge N ₂ O 25 gram 1 case for storage 1 user guide A6 size	1
CIQ-PS-L/D2/D3	New! CryoIQ PRO Aesthetic device with 1 standard tip 60 µm, L=10 mm, spray freezing Ø1-6 mm 1 dermatology tip D2, L=22 mm, spray freezing Ø7-18 mm 1 dermatology tip D3, L=22 mm, spray freezing Ø7-25 mm 1 PRO A body with lever 1 freeze limiter 1 gas cartridge N ₂ O 25 gram New! 1 case for storage 1 user guide A6 size	1
CIQ-PS-D2/GYN	New! CryoIQ PRO Gynecology device with 1 dermatology tip D2, L=22 mm, spray freezing Ø7-18 mm 1 gynecology tip, 5°, L=130 mm, spray freezing Ø9-22 mm 1 PRO body with lever 1 gas cartridge N ₂ O 25 gram 1 case for storage 1 user guide A6 size	1



GAS CARTRIDGES with OXIBLOCK® TECHNOLOGY

All our gas cartridges are equipped with a valve. The 25 gram gas cartridges fit CryoIQ® models PRO Aesthetic. The gas cartridges have a built-in 5 µm filter and are filled with medical grade N₂O gas.

Catalog No.	Description	Package Size	Min Order QTY
CIQ-GS-VN25	Gas cartridge 25 gram N ₂ O with valve for model CryoIQ® PRO Aesthetic	1	10 single package



G1 / With valve
25 gram version

ADDITIONAL TIPS

Catalog No.	Description	Package Size
CIQ-PSA-DST60	Standard Tip 60µm, L=10mm, Spray Freezing Ø1-6mm	1
CIQ-PSA-DST80	Standard Tip 80µm, L=10mm, Spray Freezing Ø7-18mm	1
CIQ-PSA-D1	Dermatology Tip 60µm, L=22mm, Spray Freezing Ø1-6mm	1
CIQ-PSA-D2	Dermatology Tip 80µm, L=22mm, Spray Freezing Ø7-18mm	1
CIQ-PSA-D3	Dermatology Tip 100µm, L=22mm, Spray Freezing Ø9-22mm	1
CIQ-PSA-D1-3	Dermatology Tip Set: 3 Tips (D1, D2, D3)	1
CIQ-PSA-A45	Angled Tip 45°, L=8cm, Spray Freezing Ø7-18mm	1
CIQ-PSA-L13	Gynecology Tip 100µm, L=130mm, Spray Freezing Ø9-22mm	1
CIQ-PSA-L13/5	Gynecology Tip 100µm, L=130mm, 5°, Spray Freezing Ø9-22mm	1

REVITALIZE

VIALS

REVITALIZE PURE

Stretch marks, acne marks, scar marks, and other skin imperfections are undesirable for anyone from an aesthetic point of view.

Indication: For all skins that needs to regenerate the texture and tonality.

Number	Description	Quantity
MYF500	5ml Bottle, Sodium Hyalurnate 12mg/ml, Hydrolyzed Collagen 5%	5 Vials/ Box



REVITALIZE VITAMINS

Stress, sun over-exposure, wrong diet, and aging the appearance. You can apply alone or mix it with PURE.

Indication: Revitalizing and illuminating.

Number	Description	Quantity
MYF501	5ml Bottle, Vitamin Complex with 69 vitamins and peptides	5 Vials/ Box



REVITALIZE BODY

Body and facial flaccidity is a direct consequence of aging and or weight variations.

Indication: Flaccidity, striae, lost laser, post peeling or scrubs, and alopecia.

Number	Description	Quantity
MYF502	5ml Bottle, Methylsilanol Mannonurate 2.5%, Dimethylaminoethanol Tartrate 1%	5 Vials/ Box



REVITALIZE SLIM

Poor diet, lack of exercise, and stress are the main reasons of excess fat accumulation.

Indication: Localized fat accumulation spot as belly, back of the arm, neck, and legs.

Number	Description	Quantity
MYF503	5ml Bottle, Phosphatidylcholine 2.5%, Sodium Deoxycholate 1.5%, Carnitine 4%	5 Vials/ Box



REVITALIZE HAIR

Specific composition to reinforce the existing hair, promote hair growth and prevent hair loss. Indication: Nourishing the scalp and promoting hair growth.

Indication: Nourishing the scalp and promoting hair growth.

Number	Description	Quantity
MYF504	10ml Bottle, DHQG, EGCG, Glicina and Zinc	5 Vials/ Box



REVITALIZE WHITE SKIN

Removal of skin spots with a gentle and efficient product. Try on is very important.

Indication: Lighten skin tone and reduce skin spots.

Number	Description	Quantity
MYF505	5ml Bottle, Kojic Acid, Retinol, Ascorbic Acid(Vitamin C)	5 Vials/ Box



REVITALIZE BOOSTER

Patent pending growth factor stabilization. Can be used for acne treatment, acne scars, stretchmarks, and firming the facial skin. Booster is not injectable.

Indication: It promotes dermal repair increasing its self-regeneration rate.

Number	Description	Quantity
MYF506	1ml Bottle, 4 ampules with epidermal growth factor(EGF)	4 Vials/ Box



QUALITY

INNOVATION

TECHNOLOGY

To order Invotec products or for more information, please contact:

6883 Phillips Industrial Boulevard • Jacksonville, Florida 32256 • U.S.A.
Tel: 800-998-8580 • Fax: 904-886-9517 • www.invotec.net

REV112023

